

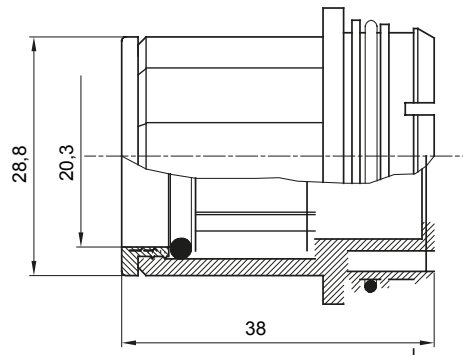

Componenti di percorso per i tubi protettivi rigidi serie RK con gradi di protezione IP40 e IP67.

Colore	Grigio RAL 7035	Caratteristiche	-
Tubi Ø (mm)	20	Codice Electrocod	21221

DIMENSIONALE

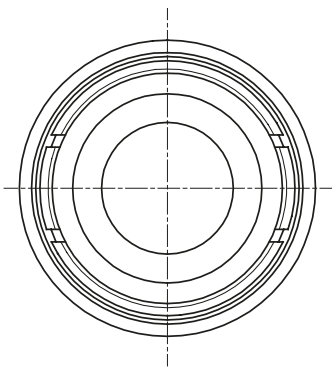

MARCHI/APPROVAZIONI

