

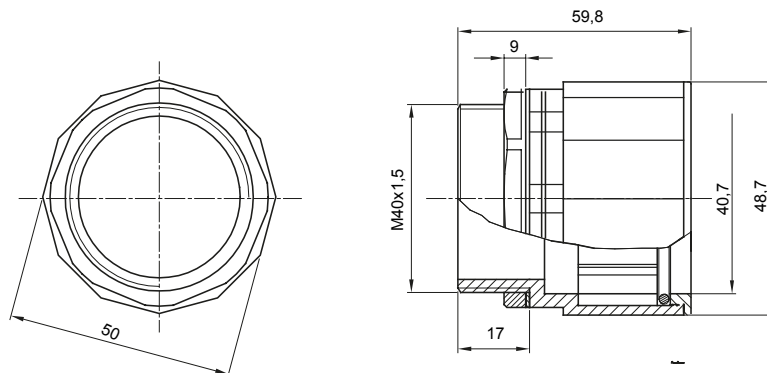

Componenti di percorso per i tubi protettivi rigidi serie RK con gradi di protezione IP40 e IP67.

Colore	Grigio RAL 7035	Grado di protezione	IP67
Passo metrico	M 40x1,5	Per fori Ø (mm)	40
Tubi Ø (mm)	40	Tipo Materiale	Halogen free secondo norma EN 50642
Codice Electrocod	21221		

DIMENSIONALE



SIMBOLOGIA TECNICA

IP

HF
HALOGEN FREE

IP67

MARCHI/APPROVAZIONI

