

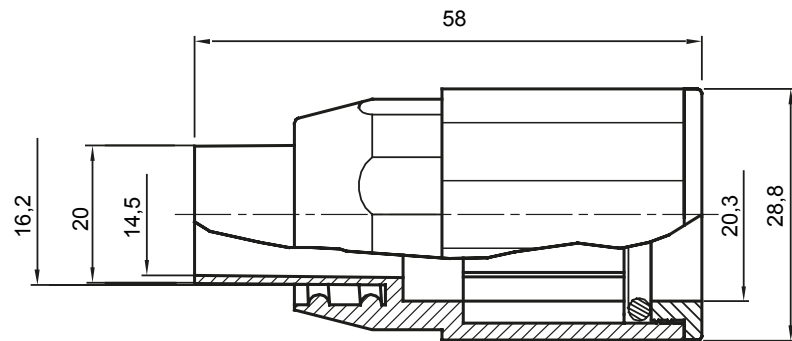

Componenti di percorso per i tubi protettivi rigidi serie RK con gradi di protezione IP40 e IP67.

| | | | |
|----------------|-------------------------------------|---------------------|-------|
| Colore | Grigio RAL 7035 | Grado di protezione | IP65 |
| Tubi Ø (mm) | 20 | Guaina Ø (mm) | 16 |
| Tipo Materiale | Halogen free secondo norma EN 50642 | Codice Electrocod | 21221 |

DIMENSIONALE

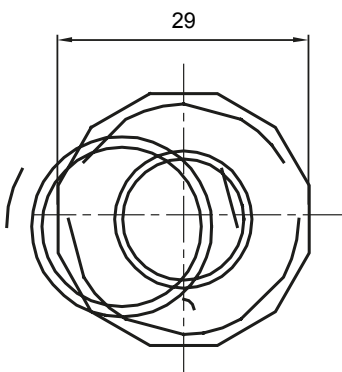

SIMBOLOGIA TECNICA

IP

HF
HALOGEN FREE

IP65

MARCHI/APPROVAZIONI

