

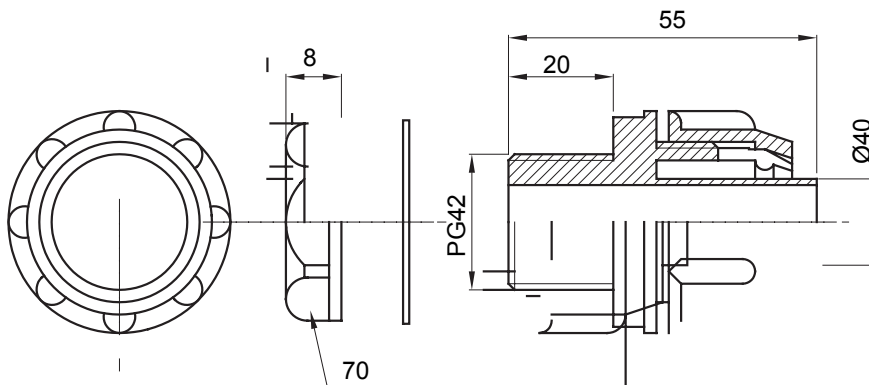

Racores de vaina rectos y giratorios con grado de protección IP54.

| | | | |
|---------|---------------|---------------------|------|
| Color | Gris RAL 7035 | Grado de protección | IP54 |
| Paso PG | 42 | Vaina Ø (mm) | 40 |
| Tipo | Fijo | Código Electrocod | 210 |

DIMENSIONAL



SIMBOLOGÍA TÉCNICA

IP

IP54

MARCAS/APROBACIONES

