

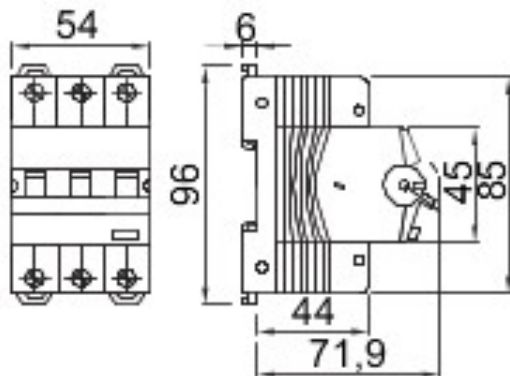

Description	RCCB WITH OVERCURRENT PROTECTION
Code	MDC 100 MA
No. of poles	2P
No. modules	2
Rated current	13 A
Rated residual operating current	30 mA
Type	A
Curve	C
Rated voltage (EN/IEC 61009-1, 61009-2-1)	110 V

Standard	IEC/EN 61009-1, IEC/EN 61009-2-1	Rated frequency (Hz)	50/60 Hz
Breaking capacity EN 61009-1 110V (Icn)	10000 A	Breaking capacity EN 61009-1 230V (Icn)	10000 A
Breaking capacity EN 61009-1 (Ics)	0.75 x Icn	Breaking capacity EN 60947-2 110V (Icu)	15 kA
Breaking capacity EN 60947-2 (Ics)	75% Icu	Insulation voltage	500 V
Level of immunity (8/20 μs)	250 A	Rated impulse withstand voltage	4 kV
Overvoltage category	III	Electrical endurance	10.000
Mechanical endurance	20.000	Section rigid cable	<=1x35 - <=2x16 - <=1x16+2x10 mm ²
Section flexible cable	<=1x35 - <=2x16 - <=1x16+2x10 mm ²	Double connection	YES (only down stream)
Rated tightening torque	2 Nm	Operating temperature	-25 +40 °C
Stocking temperature	-40 +70 °C	Auxiliaries compatibility	Yes
ReStart compatibility	Yes	Assembly position	Any

DIMENSIONAL



WIRING DIAGRAM

STANDARDS/APPROVALS

