

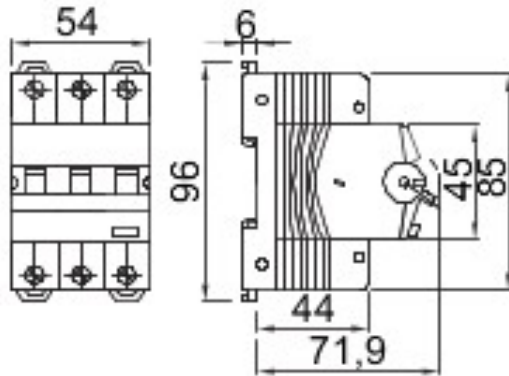

Description	RCCB WITH OVERCURRENT PROTECTION
Code	MDC 60
No. of poles	3P
No. modules	3
Rated current	6 A
Rated residual operating current	300 mA
Type	A
Curve	B
Rated voltage (EN/IEC 61009-1, 61009-2-1)	400/415 V

Standard	IEC/EN 61009-1, IEC/EN 61009-2-1	Rated frequency (Hz)	50/60 Hz
Breaking capacity EN 61009-1 400V (Icn)	6000 A	Breaking capacity EN 61009-1 (Ics)	1 x Icn
Breaking capacity EN 60947-2 400V (Icu)	6 kA	Breaking capacity EN 60947-2 (Ics)	100% Icu
Insulation voltage	500 V	Level of immunity (8/20 μs)	250 A
Rated impulse withstand voltage	4 kV	Overvoltage category	III
Electrical endurance	10.000	Mechanical endurance	20.000
Section rigid cable	<=1x35 - <=2x16 - <=1x16+2x10 mm ²	Section flexible cable	<=1x35 - <=2x16 - <=1x16+2x10 mm ²
Double connection	YES (only down stream)	Rated tightening torque	2 Nm
Operating temperature	-25 +40 °C	Stocking temperature	-40 +70 °C
Auxiliaries compatibility	Yes	Assembly position	Any

DIMENSIONAL



WIRING DIAGRAM

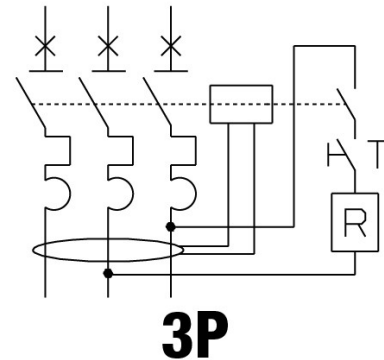

STANDARDS/APPROVALS

