

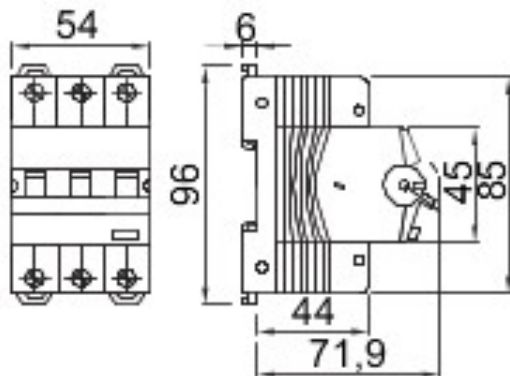

| | |
|---|----------------------------------|
| Description | RCCB WITH OVERCURRENT PROTECTION |
| Code | MDC 60 |
| No. of poles | 3P |
| No. modules | 3 |
| Rated current | 6 A |
| Rated residual operating current | 30 mA |
| Type | A |
| Curve | C |
| Rated voltage (EN/IEC 61009-1, 61009-2-1) | 400/415 V |

| | | | |
|---|---|------------------------------------|---|
| Standard | IEC/EN 61009-1, IEC/EN 61009-2-1 | Rated frequency (Hz) | 50/60 Hz |
| Breaking capacity EN 61009-1 400V (Icn) | 6000 A | Breaking capacity EN 61009-1 (Ics) | 1 x Icn |
| Breaking capacity EN 60947-2 400V (Icu) | 6 kA | Breaking capacity EN 60947-2 (Ics) | 100% Icu |
| Insulation voltage | 500 V | Level of immunity (8/20 μs) | 250 A |
| Rated impulse withstand voltage | 4 kV | Overvoltage category | III |
| Electrical endurance | 10000 | Mechanical endurance | 20.000 |
| Section rigid cable | <=1x35 - <=2x16 - <=1x16+2x10 mm ² | Section flexible cable | <=1x35 - <=2x16 - <=1x16+2x10 mm ² |
| Double connection | YES (only down stream) | Rated tightening torque | 2 Nm |
| Operating temperature | -25 +40 °C | Stocking temperature | -40 +70 °C |
| Auxiliaries compatibility | Yes | Assembly position | Any |

DIMENSIONAL



WIRING DIAGRAM

STANDARDS/APPROVALS

