

Systems of accessories for electrical installations used for residential, tertiary and industrial applications. The system consists of fasteners for pipes and cables, cable fittings, accessories for rigid pipes (RK Series) and flexible conduit (DF Series). The system include also a wide variety of cable ties (52FS Range) and terminal blocks (44 Range).

Colour	Grey RAL 7035	IP degree	-
Material	Shockproof polymer	Fixing	Clip
For external conduits (mm)	40	Glow Wire Test	750 °C
Wall-conduit axis distance (mm)	32	Operating temperature	-5 +60 °C
Electrocod	21221	Standard	EN 61386-1 (when applicable)

DIMENSIONAL

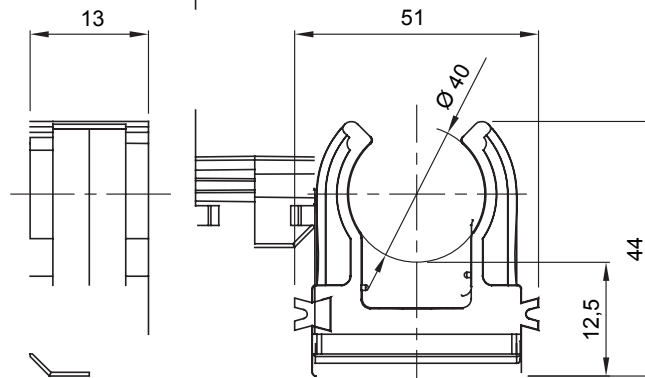

TECHNICAL SYMBOLOGY

IP

GWT

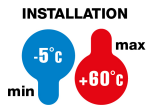

750 °C

STANDARDS/APPROVALS

