

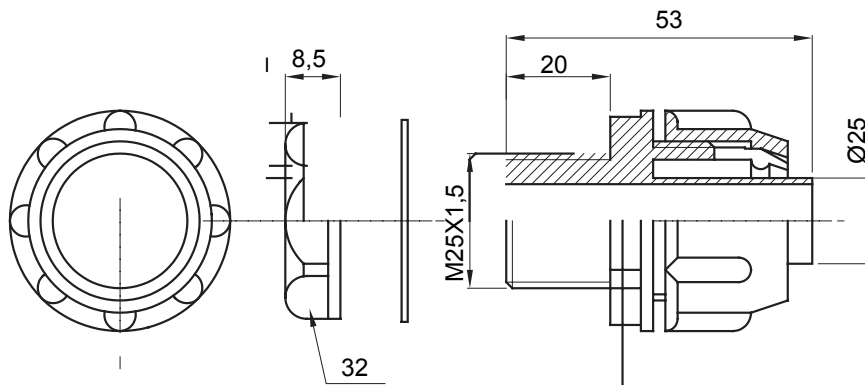

Straight and revolving coupling device for sheath with IP54 protection degree.

Colour	Grey RAL 7035	IP degree	IP54
ISO pitch	M25x1.5	Sheath Ø (mm)	25
Type	Fixed	Electrocod	210

DIMENSIONAL



TECHNICAL SYMBOLOGY

IP

IP54

STANDARDS/APPROVALS

