

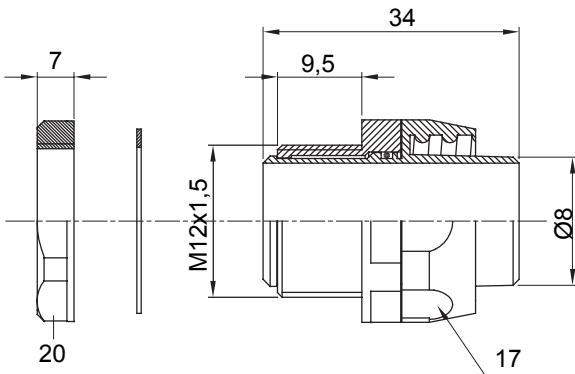

Straight and revolving coupling device for sheath with IP54 protection degree.

|           |                |               |      |
|-----------|----------------|---------------|------|
| Colour    | Black RAL 9005 | IP degree     | IP54 |
| ISO pitch | M 12x1.5       | Sheath Ø (mm) | 8    |
| Type      | Revolving      | Electrocod    | 210  |

### DIMENSIONAL



### TECHNICAL SYMBOLOGY

**IP**

IP54

### STANDARDS/APPROVALS

