

For boards LxH (mm)	396x474	For boards	44 CEP
Type of material	Insulation	Electrocod	1320

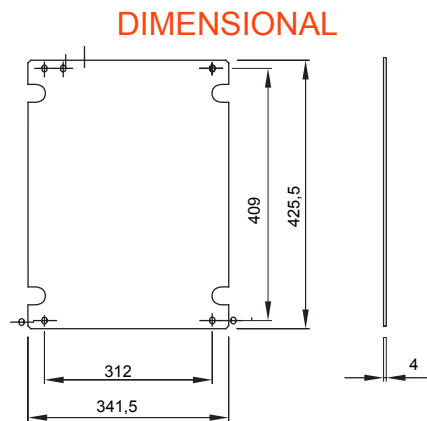

STANDARDS/APPROVALS

