



Range 44 CE - Surface-mounting watertight junction boxes in compliance with EN 60670-1 (CEI 23-48) and IEC 60670-22 (CEI 23-94) and made in high-performance technopolymers. The range includes versions with protection degree IP44, IP55, IP56 with smooth walls or with quick entry cable glands and different type of covers: blind / transparent, deep/plain, press-on/screw (in plastic, also 1/4 turn, or in metal). Available in different self-extinguishing materials (up to GWT 960 °C). Suitable for ordinary junctions, for special uses, and for industrial uses.

Insulation class	II (according to IEC 61140 standards)	Colour	Grey RAL 7035
IP degree	IP56	Material	Technopolymer GWPLAST 75
Mechanical resistance	IK08	Internal dim. LxHxD (mm)	380x300x180
Max Ø holes possible	48 mm	Lid screws (no. and type)	4 insul. sealable hinged
Application	Special uses	Glow Wire Test	960 °C
Lid	Deep screwed	Operating temperature	-25 +60 °C
Electrocod	02211	Thermo-pressure with ball	85 °C
Torque screws tightening	1.8 Newton/meter	Walls	Smooth
Accessories for insulation restoring	GW44621, GW44623		

BEHAVIOUR WITH CHEMICAL AND ATMOSPHERIC AGENTS

Saline solution	Acids		Bases		Solvents				Mineral oil	UV rays
	Concentrated	Diluted	Concentrated	Diluted	Hexane	Benzol	Acetone	Alcohol		
Resistant	Limited resistance	Resistant	Resistant	Resistant	Limited resistance	Not resistant	Not resistant	Limited resistance	Limited resistance	Limited resistance

DIMENSIONAL

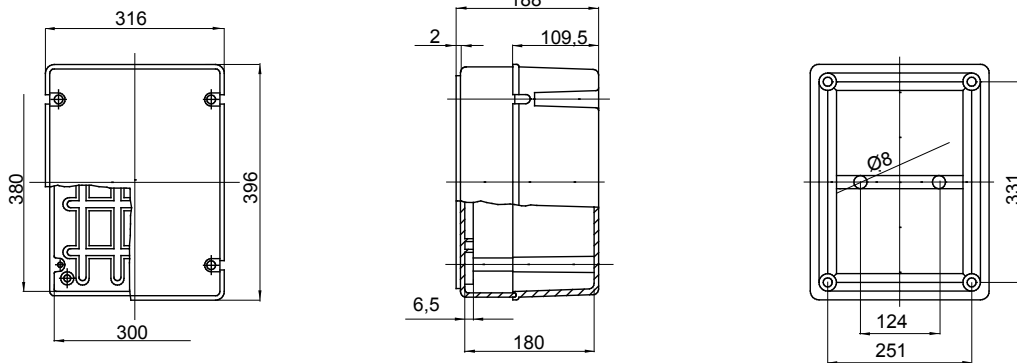

TECHNICAL SYMBOLOGY



STANDARDS/APPROVALS

