



IP65 range of watertight enclosures from 4 to 72M with smoked transparent door. The main technical features are: reversible front and back panel, removable frames and panels with windows and detachable doors with up to 180° opening and lock accessory. The enclosures can be equipped with bipolar and unipolar terminal blocks, 80 A and 125 A, with screw wiring; they allow to create simple and neat wiring reducing the set-up time of the enclosure.

Insulation class	II (according to IEC 61140 standards)	Colour	Grey RAL 7035
Outer dim. LxHxD (mm)	410x285x140	IP degree	IP65
Dispersible power (W)	38	Mechanical resistance	IK09
Rated voltage	400 V	Door colour	Smoked Transparent
No. of modules EN 50022	18	No. of modules EN 50022	18
Rated current	125 A	Glow Wire Test	650 °C
Operating temperature	-25 +60 °C	Type of material	Halogen-free in compliance with EN 60754-2
Electrocod	0321	Thermo-pressure with ball	70 °C
Accessories for insulation restoring	Screwcaps (GW44623) or fixing brackets in resin (GW44621)	Standard	EN 60670-1 (CEI 23-48) IEC60670-24 CEI 23-49
Insulation voltage	1000 V according to EN 62208 both in ac as well as in dc	Max. installable terminal blocks	1 x 18 modules

BEHAVIOUR WITH CHEMICAL AND ATMOSPHERIC AGENTS

Saline solution	Acids		Bases		Solvents				Mineral oil	UV rays
	Concentrated	Diluted	Concentrated	Diluted	Hexane	Benzol	Acetone	Alcohol		
Resistant	Not resistant	Limited resistance	Not resistant	Limited resistance	Limited resistance	Not resistant	Not resistant	Limited resistance	Limited resistance	Limited resistance

DIMENSIONAL

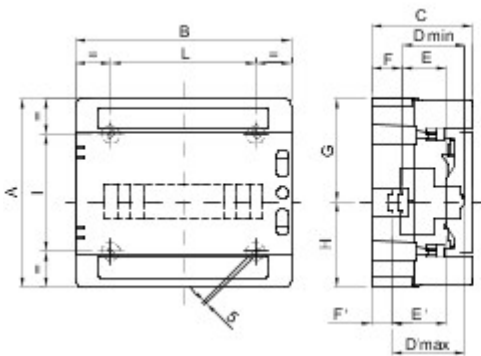

	A	B	C	D min	E	F	G	H	D max	E'	F'	NR	I	L	
8M	GW 40 102	210	215	110	75	48	15	105	105	-	-	-	4	110	115
12M	GW 40 103	260	298	140	75	48	48	117,5	142,5	112	75	21	4	161	200
18M	GW 40 106	285	410	140	75	48	48	117,5	142,5	112	75	21	4	185	310

TECHNICAL SYMBOLOGY

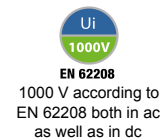
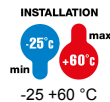
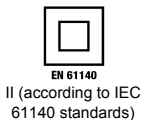

STANDARDS/APPROVALS

