



Description Interruttore non automatico scatolato
 Code MSXM 1250
 No. of poles 4P
 Rated current 1250 A
 Release -

ELECTRICAL CHARACTERISTICS

MECHANICAL CHARACTERISTICS

Standard	IEC/EN 60947-2	Execution	Fixed
Use category	AC-23 A, DC-22 A	DIN rail mounting	No
Rated frequency (Hz)	50 / 60	Can be equipped with motor operator	Yes
Rated operating voltage (Ue)	690 V ac - 250 V dc	Compatible interlock	Cable (mechanism supplied)
Rated impulse withstand voltage (Uimp)	8 kV	Terminals supplied	Front FB Extended
Overtoltage category	IV	Assembly position	Any
Insulation voltage (Ui)	800 V	Upline/downline power supply	Yes
Thermal regulation	-	Electrical life (415Vac)	4.000 cycles
Magnetic regulation	-	Mechanical life	5.000 cycles
Neutral protection	-	Operating temperature	-5°C +65°C
Total power loss	281.24 W	Stocking temperature	-20° +65°
Rated short-circuit current making capacity (Icm)	32	Weight (kg)	23.4
Rated short-time withstand current for 0,3s (Icw)	15 kA	Width	280 mm
I _{dn} regulation	-	Height	370 mm
DT regulation	-	Depth	120 mm
SERVICE BREAKING CAPACITY (ICU)		RATED BREAKING CAPACITY (ICS)	
220/240Vac	-	220/240Vac	-
400/415Vac	-	400/415Vac	-
440Vac	-	440Vac	-
525Vac	-	525Vac	-
690Vac	-	690Vac	-
250Vdc	-	250Vdc	-

DIMENSIONAL

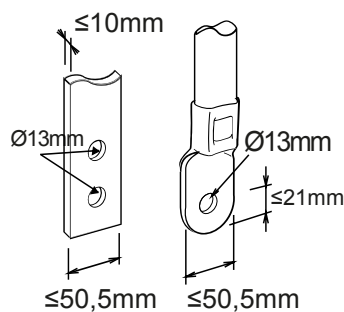



Product Data Sheet

GWD9454B

MSX

STANDARDS/APPROVALS

GEWISS S.p.A. Via A. Volta, 1
24069 Cenate Sotto - Bergamo - Italy
tel. +39 035 94 61 11 fax +39 035 94 69 09
Company subject to the management and
coordination of Polifin S.p.A.

www.gewiss.com
sat@gewiss.com
Last update 29/04/2026

Data, measures, designs and pictures are shown
only as informative purposes,
and could be changed without previous notice