

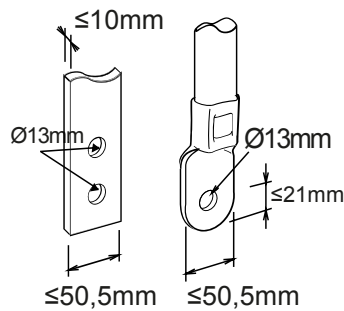

Description Interruttore automatico scatolato
 Code MSXE 1600
 No. of poles 4P
 Rated current 1600 A
 Release Electronic

ELECTRICAL CHARACTERISTICS		MECHANICAL CHARACTERISTICS	
Standard	IEC/EN 60947-2	Execution	Fixed
Use category	B	DIN rail mounting	No
Rated frequency (Hz)	50 / 60	Can be equipped with motor operator	Yes
Rated operating voltage (Ue)	690 Vac	Compatible interlock	-
Rated impulse withstand voltage (Uimp)	8 kV	Terminals supplied	Front FB Extended
Overvoltage category	IV	Assembly position	Any
Insulation voltage (Ui)	800 V	Upline/downline power supply	Yes
Thermal regulation	0,4 - 0,5 - 0,63 - 0,8 - 0,9 - 0,95 - 1 x In	Electrical life (415Vac)	2.000 cycles
Magnetic regulation	Electronic LSI	Mechanical life	5.000 cycles
Neutral protection	50% - 100% x Ir	Operating temperature	-5°C +65°C
Total power loss	225.28 W	Stocking temperature	-20° +65°
Rated short-circuit current making capacity (Icm)	-	Weight (kg)	35
Rated short-time withstand current for 0,3s (Icw)	20 kA	Width	280 mm
I _{dn} regulation	-	Height	370 mm
DT regulation	-	Depth	140 mm
SERVICE BREAKING CAPACITY (ICU)		RATED BREAKING CAPACITY (ICS)	
220/240Vac	85 kA	220/240Vac	65 kA
400/415Vac	50 kA	400/415Vac	38 kA
440Vac	45 kA	440Vac	34 kA
525Vac	30 kA	525Vac	23 kA
690Vac	20 kA	690Vac	15 kA
250Vdc	-	250Vdc	-

DIMENSIONAL





Product Data Sheet

GWD9425

MSX

STANDARDS/APPROVALS

GEWISS S.p.A. Via A. Volta, 1
24069 Cenate Sotto - Bergamo - Italy
tel. +39 035 94 61 11 fax +39 035 94 69 09
Company subject to the management and
coordination of Polifin S.p.A.

www.gewiss.com
sat@gewiss.com
Last update 01/05/2026

Data, measures, designs and pictures are shown
only as informative purposes,
and could be changed without previous notice