

Description Interruttore automatico scatolato
 Code MSXE 160
 No. of poles 4P
 Rated current 125 A
 Release Electronic

ELECTRICAL CHARACTERISTICS		MECHANICAL CHARACTERISTICS	
Standard	IEC/EN 60947-2	Execution	Fixed - Plug-in
Use category	A	DIN rail mounting	No
Rated frequency (Hz)	50 / 60	Can be equipped with motor operator	Yes
Rated operating voltage (Ue)	690 Vac	Compatible interlock	Lever – Cable
Rated impulse withstand voltage (Uimp)	8 kV	Terminals supplied	Front FC
Overvoltage category	IV	Assembly position	Any
Insulation voltage (Ui)	800 V	Upline/downline power supply	Yes
Thermal regulation	0,4 - 0,5 - 0,63 - 0,8 - 0,9 - 0,95 - 1 x In	Electrical life (415Vac)	10.000 cycles
Magnetic regulation	Electronic LSI	Mechanical life	30.000 cycles
Neutral protection	100% x Ir	Operating temperature	-5°C +65°C
Total power loss	21.88 W	Stocking temperature	-20° +65°
Rated short-circuit current making capacity (Icm)	-	Weight (kg)	3.1
Rated short-time withstand current for 0,3s (Icw)	-	Width	140 mm
I _{dn} regulation	-	Height	165 mm
DT regulation	-	Depth	103 mm
SERVICE BREAKING CAPACITY (ICU)		RATED BREAKING CAPACITY (ICS)	
220/240Vac	85 kA	220/240Vac	85 kA
400/415Vac	65 kA	400/415Vac	36 kA
440Vac	50 kA	440Vac	25 kA
525Vac	25 kA	525Vac	25 kA
690Vac	7,5 kA	690Vac	7,5 kA
250Vdc	-	250Vdc	-

DIMENSIONAL

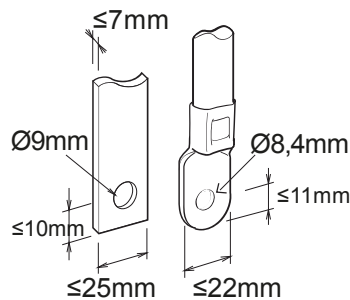

STANDARDS/APPROVALS

