

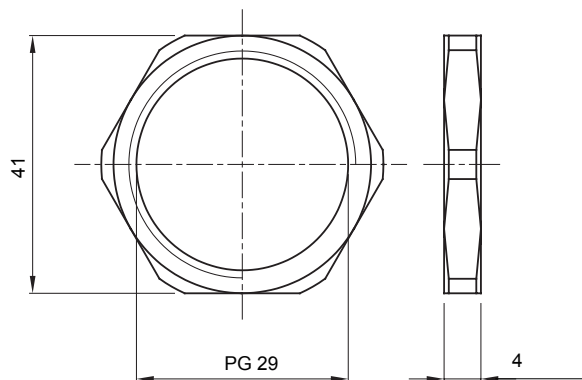

Systems of accessories for electrical installations used for residential, tertiary and industrial applications. The system consists of fasteners for pipes and cables, cable fittings, accessories for rigid pipes (RK Series) and flexible conduit (DF Series). The system include also a wide variety of cable ties (52FS Range) and terminal blocks (44 Range).

Material	Nickel-plated brass	Description	Fixing nut
Type of pitch	PG29	Area	1 (G) - 20 (D)
Electrocod	3651		

DIMENSIONAL



STANDARDS/APPROVALS

