

Systems of accessories for electrical installations used for residential, tertiary and industrial applications. The system consists of fasteners for pipes and cables, cable fittings, accessories for rigid pipes (RK Series) and flexible conduit (DF Series). The system include also a wide variety of cable ties (52FS Range) and terminal blocks (44 Range).

IP degree	IP68 (at 10 bar)	Material	Nickel-plated brass
For cables Ø (mm)	from 4 to 8	Description	Cable gland
Type of pitch	PG9	Mounting hole Ø (mm)	16
Area	1 (G) - 20 (D)	Electrocod	230
Ambient temperature	-60 °C ≤ Ta ≤ +95 °C	Standard	EN 50262 - IEC 62444 - EN 60079-0 - EN60079-7 - EN 60079-31 - EN 60079-7 - EN 60079-31 - DIN 40430
Installation temperature	-20 +95 °C	ATEX Classification	2G 1D Ex e II tD A20 IP68

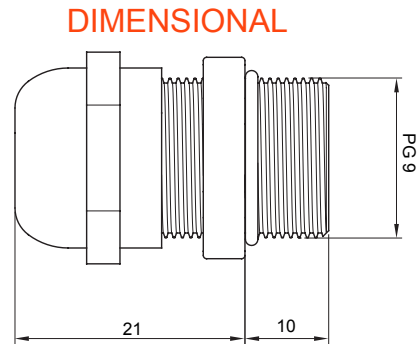

### TECHNICAL SYMBOLOGY

**IP**

IP68 (at 10 bar)

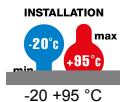

### STANDARDS/APPROVALS

