

Systems of accessories for electrical installations used for residential, tertiary and industrial applications. The system consists of fasteners for pipes and cables, cable fittings, accessories for rigid pipes (RK Series) and flexible conduit (DF Series). The system include also a wide variety of cable ties (52FS Range) and terminal blocks (44 Range).

IP degree	IP68 (at 3 bar)	Material	Nickel-plated brass
For cables Ø (mm)	from 4 to 9	Description	Cable gland
Type of pitch	PG11	Operating temperature	-30 +100 °C
Electrocod	3651	Standard	EN 50262 - IEC62444 - DIN 40430

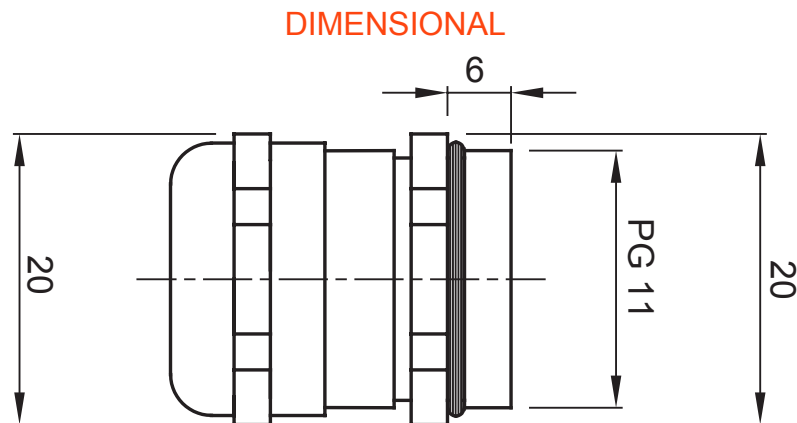

TECHNICAL SYMBOLOGY

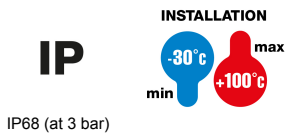

STANDARDS/APPROVALS

