



70 RT HP is a complete offer of rotary isolator switches from 16 A to 160 A, available in boxes both in insulating material and aluminium, in control or emergency versions, compatible with the main applications for residential, tertiary and industrial contexts.

DC versions for photovoltaic applications are also available from 16 A to 40 A in insulating box.

The series is completed with versions for board from 16 A to 1000 A and for DIN rail fixing from 16 A to 63 A, which can be equipped with auxiliary contacts.

The devices have been designed to reduce wiring time, facilitate installation and guarantee the maximum safety and robustness even in the most demanding conditions.

ELECTRICAL CHARACTERISTICS

ELECTRICAL CHARACTERISTICS		- FUNCTIONAL CHARACTERISTICS		-
Circuit breaker	Rotary isolator	Version		For fixing on DIN rail
Rated current (A)	63	No. of modules EN 50022		5
No. of poles	4P	Type		Control
Rated operational current AC-21A (415 V) (A)	63	Knob colour		Black
Rated operational current AC-22A (415 V) (A)	63	Lockable		No
Rated operational current AC-23A (415 V) (A)	63	ACCESSORIES		-
Cable section	2,5-25 mm ²	Type of accessory		Max. 2 auxiliary contacts (1 per side)

DIMENSIONAL

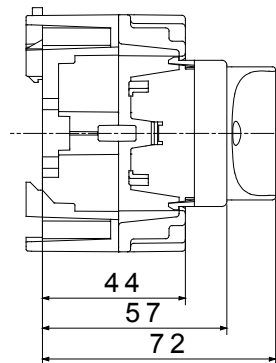
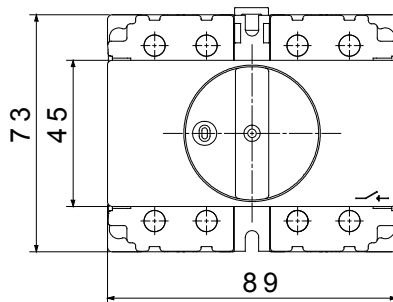

STANDARDS/APPROVALS

