

GW 68 431

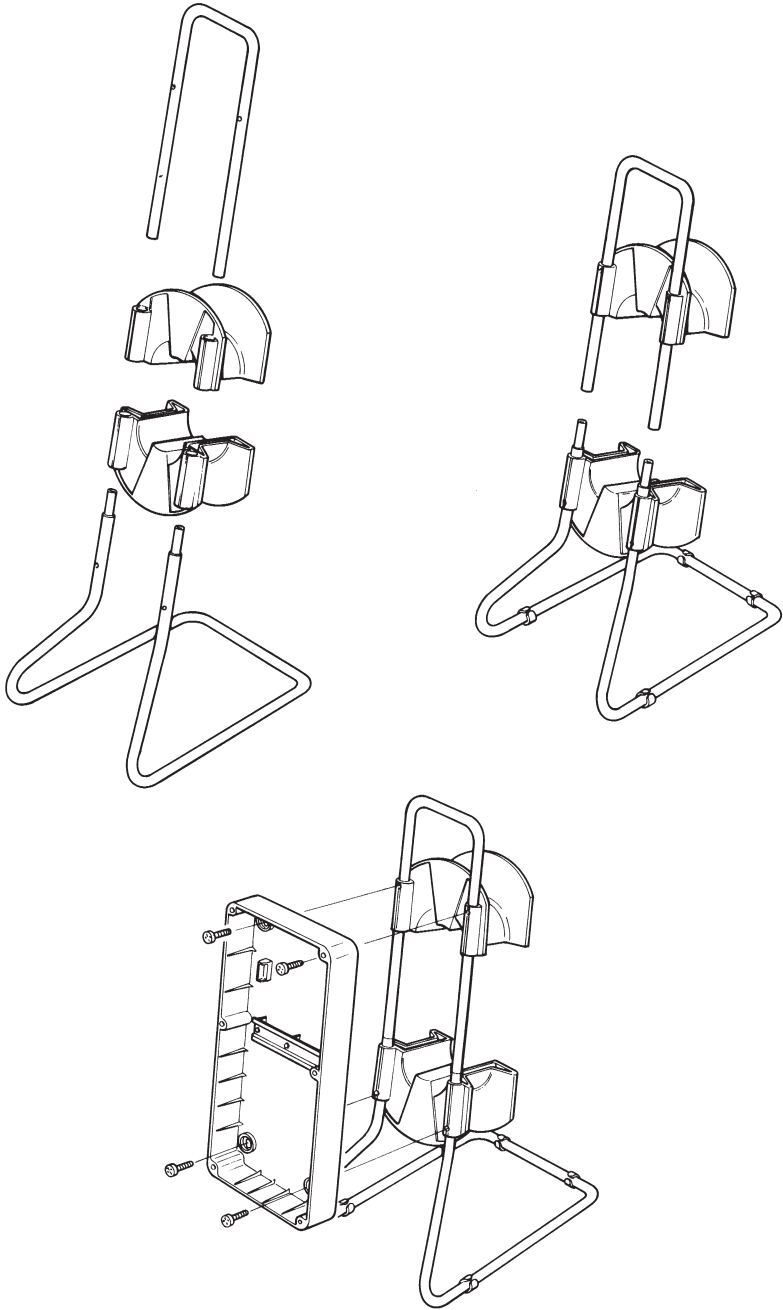

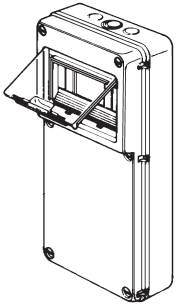

**GW 68 002 N**

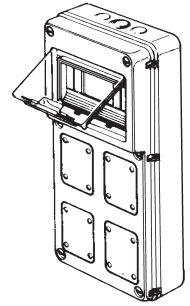
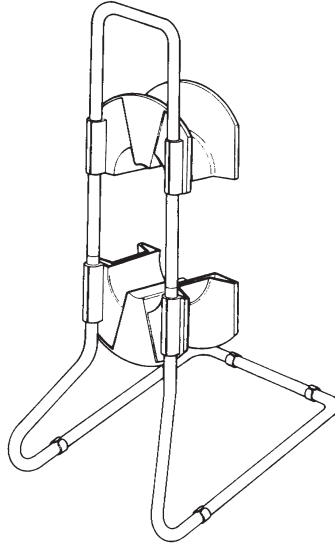

**GW 68 003 N**

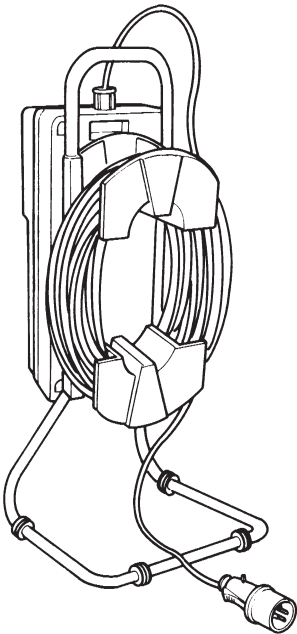

**MAX 20 m**  
H07RN-F 5x4 mm<sup>2</sup>

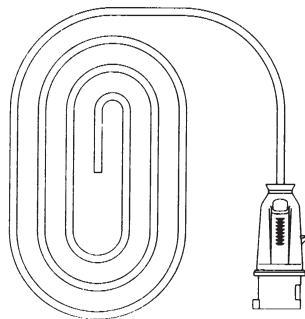

**MAX 7 kW**  
15 m H07RN-F 5x2,5 mm<sup>2</sup>

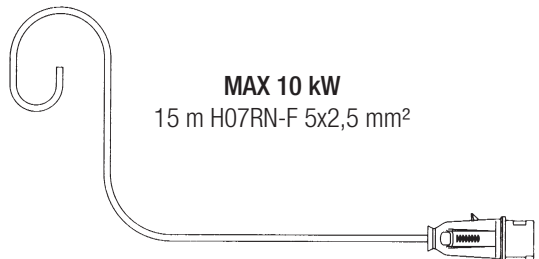

**MAX 10 kW**  
15 m H07RN-F 5x2,5 mm<sup>2</sup>

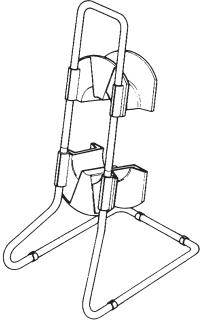
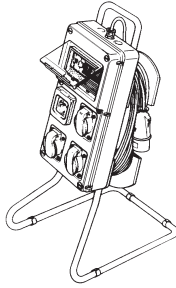
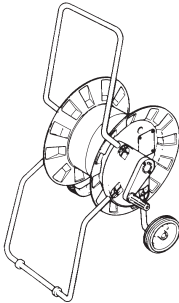
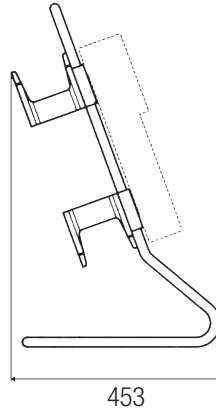
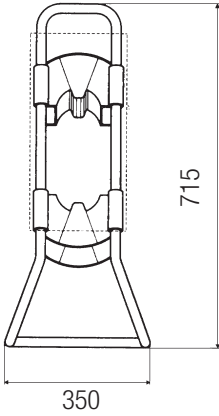
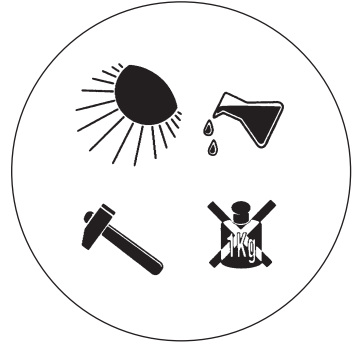
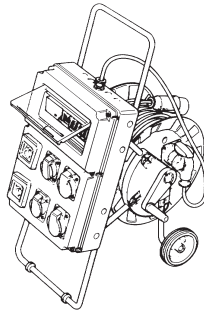
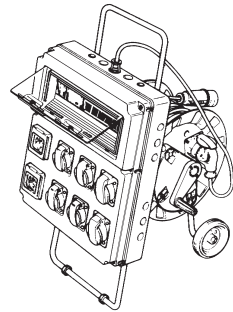
**GW 68 431****GW 68 401 N****GW 68 432****GW 68 411 N****GW 68 421 N**

Punto di contatto indicato in adempimento ai fini delle direttive e regolamenti UE applicabili:  
 Contact details according to the relevant European Directives and Regulations:  
 GEWISS S.p.A. Via D.Bosatelli, 1 IT-24069 Cenate Sotto (BG) Italy tel: +39 035 946 111 E-mail: qualitymarks@gewiss.com

According to applicable UK regulations, the company responsible for placing the goods in UK market is:  
 GEWISS UK LTD - Unity House, Compass Point Business Park, 9 Stocks Bridge Way, ST IVES  
 Cambridgeshire, PE27 5JL, United Kingdom tel: +44 1954 712757 E-mail: gewiss-uk@gewiss.com



**+39 035 946 111**  
 8:30 - 12:30 / 14:00 - 18:00  
 lunedì - venerdì / monday - friday



[www.gewiss.com](http://www.gewiss.com)

