

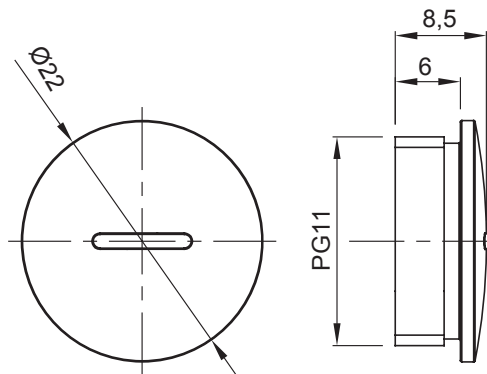

Systems of accessories for electrical installations used for residential, tertiary and industrial applications. The system consists of fasteners for pipes and cables, cable fittings, accessories for rigid pipes (RK Series) and flexible conduit (DF Series). The system include also a wide variety of cable ties (52FS Range) and terminal blocks (44 Range).

Colour	Grey RAL 7035	IP degree	IP65
Material	Nylon	Pitch	PG11
Electrocod	36B		

DIMENSIONAL



TECHNICAL SYMBOLOGY

IP

IP65

STANDARDS/APPROVALS