

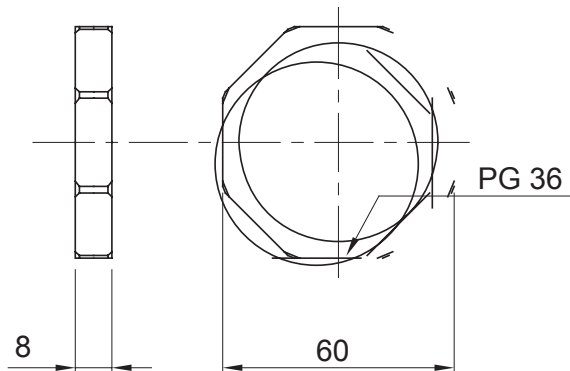

Systems of accessories for electrical installations used for residential, tertiary and industrial applications. The system consists of fasteners for pipes and cables, cable fittings, accessories for rigid pipes (RK Series) and flexible conduit (DF Series). The system include also a wide variety of cable ties (52FS Range) and terminal blocks (44 Range).

Colour	Grey RAL 7035	Material	Nylon
Pitch	PG36	Description	Fixing nut
Type	Hexagon	Electrocod	36B

DIMENSIONAL



STANDARDS/APPROVALS