

For boards LxH (mm)	316x396	For boards	44 CEP
Type of material	Galvanized metal	Electrocod	1320

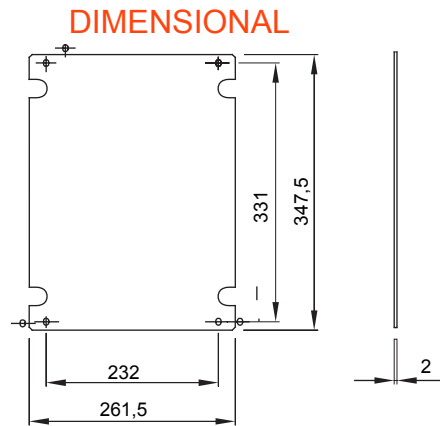

STANDARDS/APPROVALS

