

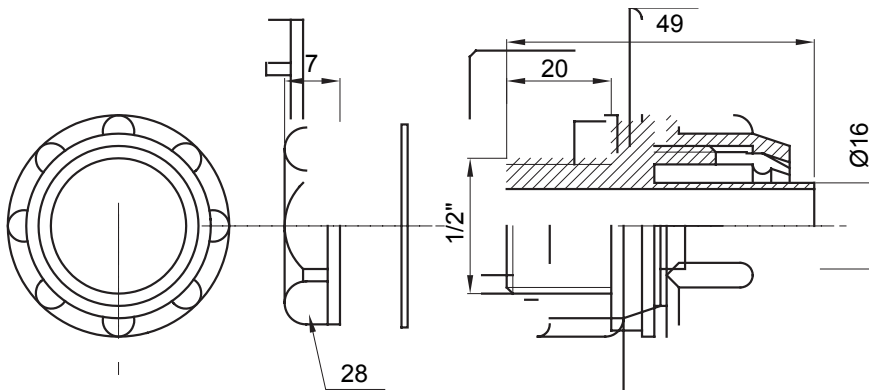

Straight and revolving coupling device for sheath with IP54 protection degree.

Colour	Grey RAL 7035	IP degree	IP54
GAS pitch	1/2"	Sheath Ø (mm)	16
Type	Fixed	Electrocod	210

### DIMENSIONAL



### TECHNICAL SYMBOLOGY

**IP**

IP54

### STANDARDS/APPROVALS