

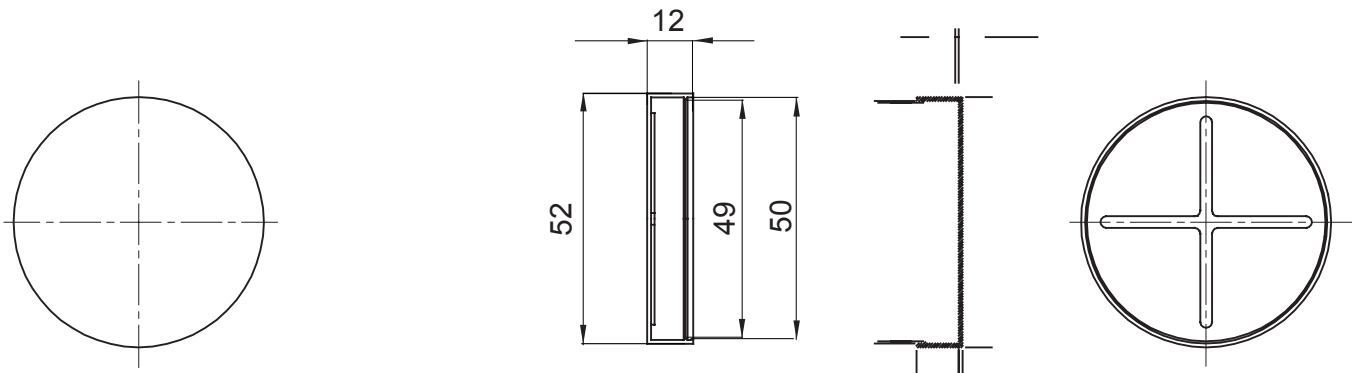

Colour	Grey RAL 7035	Material	PP
Conduits Ø (mm)	50	Electrocod	210

DIMENSIONAL



STANDARDS/APPROVALS