

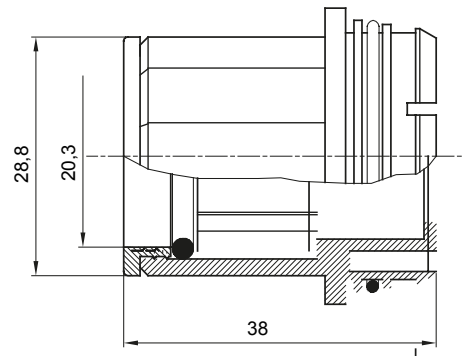

Routing components for rigid protective conduits with IP40 and IP67 protection degree.

Colour	Grey RAL 7035	Characteristics	-
Conduits Ø (mm)	20	Electrocod	21221

DIMENSIONAL

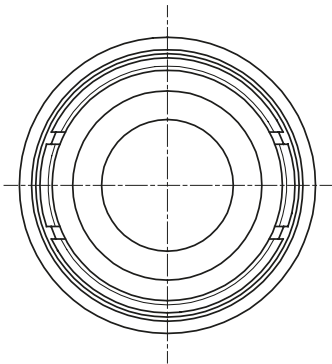

STANDARDS/APPROVALS

