

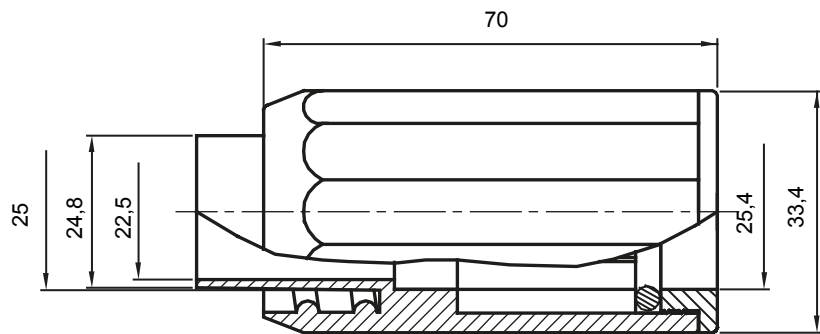

Componenti di percorso per i tubi protettivi rigidi serie RK con gradi di protezione IP40 e IP67.

Colore	Grigio RAL 7035	Grado di protezione	IP65
Tubi Ø (mm)	25	Guaina Ø (mm)	25
Tipo Materiale	Halogen free secondo norma EN 50642	Codice Electrocod	21221

DIMENSIONALE

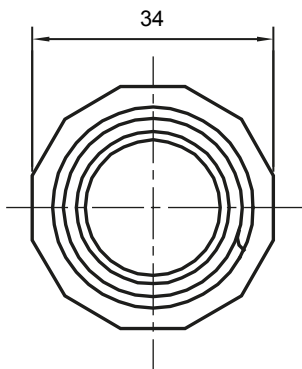

SIMBOLOGIA TECNICA

IP

HF
HALOGEN FREE

IP65

MARCHI/APPROVAZIONI

