



Complete system for the connection and distribution of LAN networks in residential and tertiary sector environments. The range includes fibre optic solutions, wall panels, floor cabinets and copper wiring products.

Data Center boards and cabinets are available in a wide choice of modularity and different depths (up to 1000 mm), for adapting to every application need.

Made with high quality materials (static flow at full load can reach 1000kg), the products are also characterised by their simple wiring (thanks to large internal volumes) and complete customisation, with removable and reversible front doors.

kategoria	Szafka ścienna 19"	Materiał	Stal
Wykończenie	Teksturowane	Kolor	Szary (RAL 7035)
Ciągłość okablowania	15 U	Rodzaj drzwi	Odwracalne
Otwór drzwiowy	180°	Nośność statyczna	50 Kilogramm
Liczba słupków	2	Głębokość (mm)	600 mm
Śred. zewn. LxHxD (mm)	600x740x600	Ochrona IP	IP20
Electrocod	3752		

DIMENSIONAL

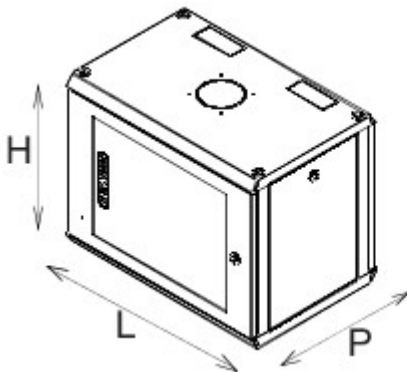

	H	L	P	
GW 38 406	335	600	400	6U
GW 38 407	470	600	400	9U
GW 38 408	605	600	400	12U
GW 38 409	740	600	400	15U
GW 38 418	605	600	600	12U
GW 38 419	740	600	600	15U

TECHNICAL SYMBOLOGY

IP

IP20

STANDARDS/APPROVALS

CE