

Wide range of control devices, sockets for power supply (conforming to national and international standards) signal pick-up, climate control, comfort management, technical alarm signalling and emergency lighting management. The ChoruSmart modular devices are available in five colours, glossy white, satin white, natural beige, satin black and lacquered titanium and in various sizes from 1/2, 1, 2 and 3 modules. Thanks to the mounting supports for rectangular, square and round boxes, endless combinations can be created with the ChoruSmart range of plates.

kategoria	Przycisk	Przycisk	Z wymienn? naturaln? soczewk?
Kolor	Naturalny satynowy be?	Opis	1P NO - 16A pod?wietlany
wyj?ciowe	250 V ac	Norma	(EN 60669-1)
Rezystancja przy napi?ciu probierczym	2000 V przy 50 Hz przez 1 minut?	Rezystancja izolacji	> 5 Momów
Zaciski okablowania	Ze ?rub?	Wyd?u?ona praca (liczba zmian po?o?enia)	40,000 przy In 250 V AC cos?=0,6
Twardo?? kulkowa	125 °C	Pr?ba roz?arzonym drutem	850 °C
Uchwyt zacisku na trakcji kablowej	> 50 N	Zakres dokr?cenia zacisku przewody elastyczne (mm <sup>2</sup> )	min. 0,75 - maks. 2x4
Zakres dokr?cenia zacisku przewody sztywne (mm <sup>2</sup> )	min. 0,5 - maks. 2x2,5	ilo?? modu?ów	3
Materia?	Technopolimerowy	Electrocod	0130

### DIMENSIONAL

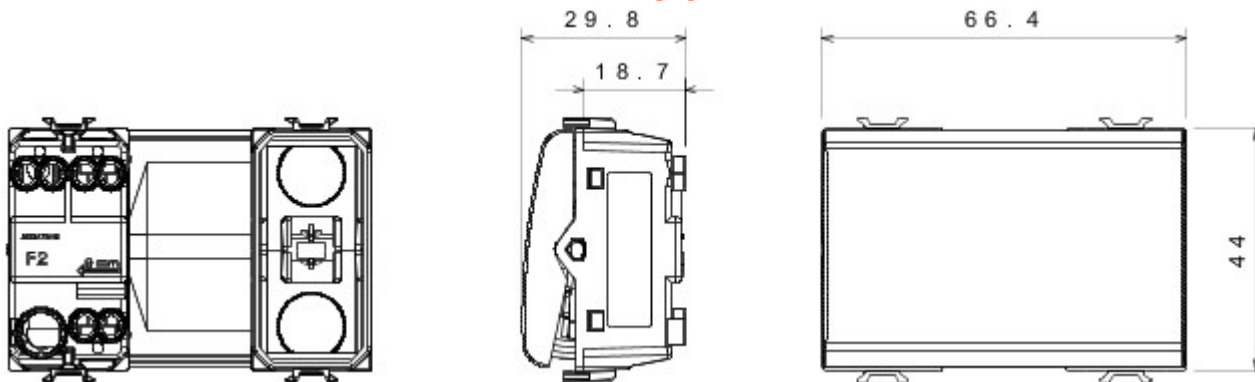

### TECHNICAL SYMBOLOGY



### STANDARDS/APPROVALS

