

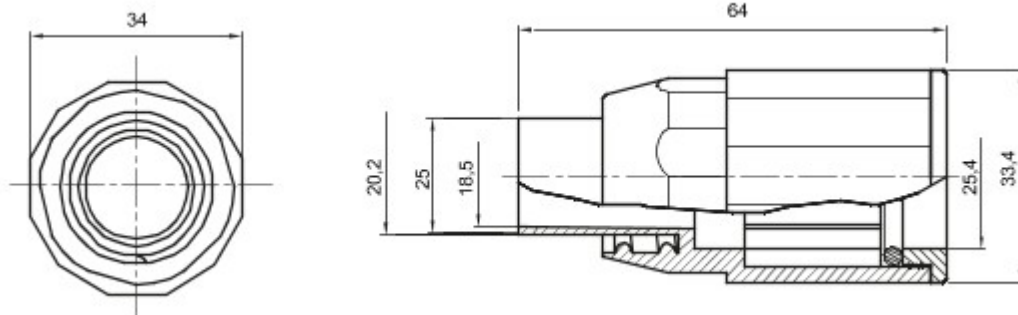

Elementy przeznaczone do trasowania sztywnych osłon kablowych o stopniu ochrony IP40 oraz IP67..

Kolor	Szary RAL 7035	Ochrona IP	IP65
Ø przewodów (mm)	25	Oslona Ø (mm)	20
Rodzaj materiału	Bezhalogenowe zgodnie z normą EN 50267-2-2	Electrocod	21221

DIMENSIONAL



TECHNICAL SYMBOLOGY



IP65

STANDARDS/APPROVALS

