

70 RT HP is a new range of 16A to 160A switch disconnectors in isolating material and metal, supplied in a box. Available in control and emergency versions, the range is completed by board versions for front-panel or DIN rail assembly, in 16 to 63A options, all of which can be equipped with auxiliary contacts. These devices have been designed to deliver the ultimate in reliability, functionality and performance. They offer a technologically advanced solution that simplifies installation, reduces wiring times and ensures maximum safety and robustness, even in the most demanding conditions, thanks to the use of high-performance materials.

Wersja	Skrzynka	Materiał	Metal
Typ	Dla sytuacji awaryjnych	Prąd znamionowy (A)	32
Liczba biegunów	4P	Wyłączniki	Rotary izolator
Ochrona IP	IP66	Odporność na wstrząsy	IK10 (IK08 knob)
Temperatura otoczenia	-25 +60 °C	Lid screws (no. and type)	4 metal screws
otworów wejście	2 x M20 + 2 x M25	Zamykany	YES (max. 3 locks in OFF)
Typ wyposażenie dodatkowe	Max. 2 auxiliary contacts	Current in AC22 (415V)	32
Current in AC23 (415V)	32	Kabel przekrój	Maks. 10 mm ²
Śred. zewn. LxHxD (mm)	140x165x64	Electrocod	1742

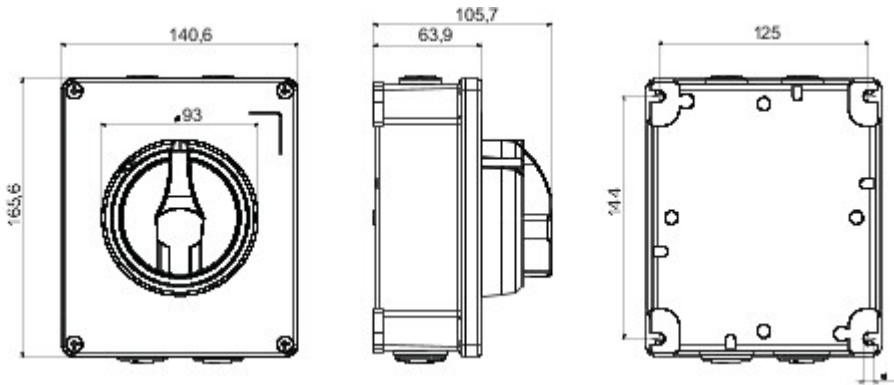

DIMENSIONAL



TECHNICAL SYMBOLOGY

IP

IP66

IK

IK10 (IK08 knob)

STANDARDS/APPROVALS

