



70 RT HP is a complete offer of rotary isolator switches from 16 A to 160 A, available in boxes both in insulating material and metal, in control or emergency versions, compatible with the main applications for residential, tertiary and industrial contexts.

DC versions for photovoltaic applications are also available from 16 A to 40 A in insulating box.

The series is completed with versions for board from 16 A to 800 A and for DIN rail fixing from 16 A to 63 A, which can be equipped with auxiliary contacts.

The devices have been designed to reduce wiring time, facilitate installation and guarantee the maximum safety and robustness even in the most demanding conditions.

Wy??czniki	Izolator obrotowy	Wersja	Skrzynka
Materia?	Metal	Typ	Sterowanie
Pr?d znamionowy (A)	63	Liczba biegunów	4P
Kolor ga?ki	Czarny	Zamykany	TAK (maks. 3 blokady w trybie ON i OFF)
Ochrona IP	IP66	Odporno?? na wstrz?szy	IK10 (puszka); IK08 (pokr?t?o)
Temperatura otoczenia	-25 +60 °C	?ruby pokrywy (nr i typ)	4 metalowe ?ruby
Pr?d w AC21A (415V)	63	otworów wej?cie	4xM32
Pr?d w AC22A (415V)	63	Typ wyposa?enie dodatkowe	Maks. 2 styki pomocnicze (1 na stron?)
Pr?d w AC23A (415V)	63	Kabel przekrój	2,5-25 mm ²



DIMENSIONAL

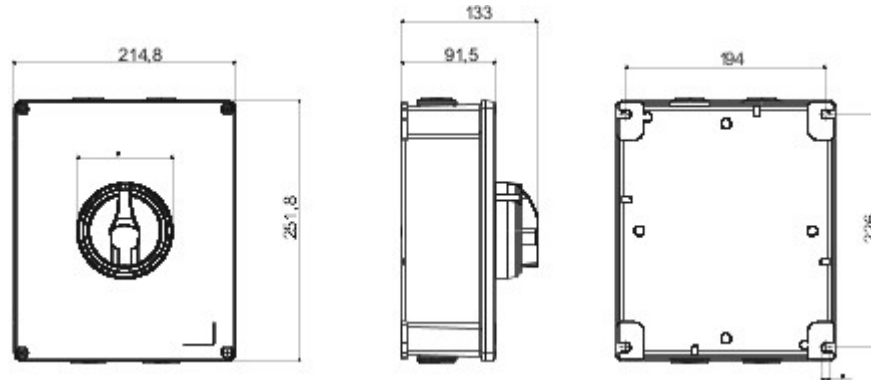

TECHNICAL SYMBOLOGY

IP

IP66

IK

IK10 (puszka); IK08 (pokr?t?o)

STANDARDS/APPROVALS

