

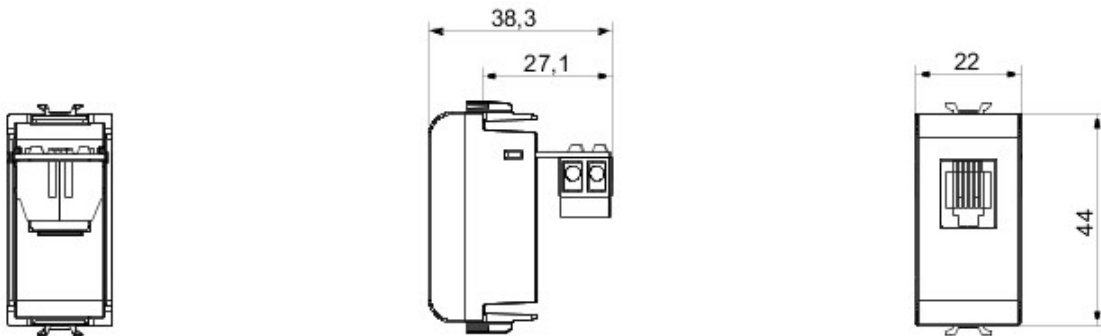

Wide range of switches, energy sockets (compliant with national and international standards), data sockets, devices for the management of climate control, comfort, technical alarms signalling, emergency lighting. The Chorus modular devices are available in four colors, glossy white, satin black, painted titanium and glossy ivory and in different modularities, 1/2, 1, 2 and 3 modules. Thanks to the frame supports for rectangular, square and round boxes, the devices allow you to create endless combinations with the range of Chorus plates.

Category	Telephone socket-outlet	Description	RJ11
Colour	Titanium	Type	In out
Connection	Impact tool	No. Chorus modules	1
Electrocod	3720		

DIMENSIONAL



STANDARDS/APPROVALS



GEWISS S.p.A. Via A. Volta, 1
24069 Cenate Sotto - Bergamo - Italy
tel. +39 035 94 61 11 fax +39 035 94 69 09

www.gewiss.com
sat@gewiss.com
Last update 24/10/2019

Data, measures, designs and pictures are shown only as informativ purposes, and could be changed without previous notice