

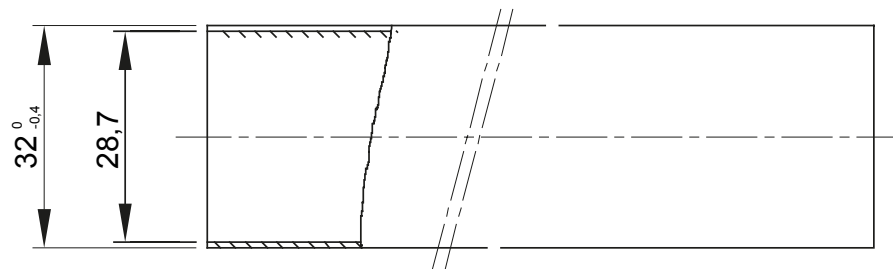

Light rigid conduits RK9 range, made of PVC, classification 22211, available in the following versions:
 2 m length, grey RAL 7035 colour and five diameters, from 16 to 40 mm with sleeved end;
 3 m length, grey RAL 7035 colour and six diameters, from 16 to 50 mm with straight end or sleeved end;
 3 m length, white RAL 9010 colour and five diameters, from 16 to 40 mm with straight end.
 Suitable for electrical and/or data transmission systems and to be installed in uncrowded areas. They represent the best solution for those who do not require a high impact resistance but at the same time do not want to compromise on quality. They can be integrated with spiraled sheaths and wall mounting enclosures. Completing the offer, a wide range of accessories and routing components from IP40 to IP67 protection rating. The RK9 conduits comply with Product Standard EN 61386-1 and EN 61386-21.

Couleur	Gris RAL 7035	Matière	PVC
Longueur (m)	3	Conduits Ø (mm)	32
Test du fil incandescent	960 °C	Résistance à la compression	2 (Léger- 320 N)
Résistance aux chocs	2 (Éclairage -320 N)	Résistance à la flexion	1 (Rigide)
Caractéristiques électriques	2 (Avec caractéristiques d'isolation électrique)	Protection contre la pénétration de corps solides sans accessoires	0
Protection contre la pénétration des liquides sans accessoires	0	Résistance à la corrosion	PVC naturellement résistant à la corrosion
Résistance à la propagation de la flamme	1 (non propagateur de la flamme)	Protection contre la pénétration de corps solides avec accessoires	0 (selon accessoires utilisés)
Protection contre la pénétration des liquides avec accessoires (selon accessoires utilisés)	0	Norme	EN 61386-1 EN 61386-22
Famille	RK9	Classification	22211

DIMENSIONS

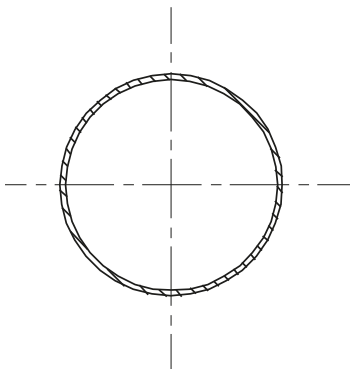

SYMBOLE TECHNIQUE



NORMES ET HOMOLOGATIONS

