



Descripción Interruttore non automatico scatolato  
 Código MSXM 1250  
 N° polos 3P  
 Corriente nominal 1250 A  
 Disparador -

#### ELECTRICAL CHARACTERISTICS

Norma de referencia	IEC/EN 60947-2
Categoría de uso	AC-23A, DC-22A
Frecuencia nominal (Hz)	50 / 60
Rated operating voltage (Ue)	690 Vac - 250 Vdc
Tensión nominal de tensión soportada (Uimp)	8 kV
Categoría de sobretensiones	IV
Tensión de aislamiento (Ui)	800 V
Thermal regulation	-
Magnetic regulation	-
Neutral protection	-
Total power loss	210.93 W
Rated short-circuit current making capacity (Icm)	32
Rated short-time withstand current for 0,3s (Icw)	15 kA
I <sub>dn</sub> regulation	-
DT regulation	-

#### SERVICE BREAKING CAPACITY (ICU)

220/240Vac
400/415Vac
440Vac
525Vac
690Vac
250Vdc

#### MECHANICAL CHARACTERISTICS

Ejecución	Fijo
DIN rail mounting	No
Accessorabile con comando motore	Si
Compatible interlock	A filo (meccanismo in dotazione)
Terminals supplied	Parte delantera FB extendida
Posición de montaje	Cualquier
Upline/downline power supply	Si
Electrical life (415Vac)	4.000 cycles
Mechanical life	5.000 cycles
Temperatura de empleo	-5°C +65°C
Temperatura de almacenaje	-20° +65°
Peso (kg)	18.2
Ancho	210 mm
Altura	370 mm
Profundidad	120 mm

#### RATED BREAKING CAPACITY (ICS)

220/240Vac	-
400/415Vac	-
440Vac	-
525Vac	-
690Vac	-
250Vdc	-

### DIMENSIONAL

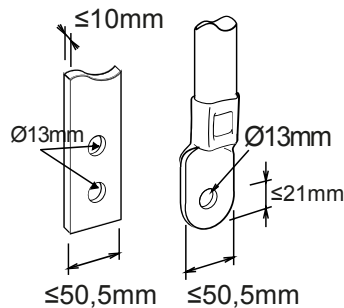



Ficha Técnica Producto

**GWD9453B**

Gama MSX

MARCAS/APROBACIONES

