

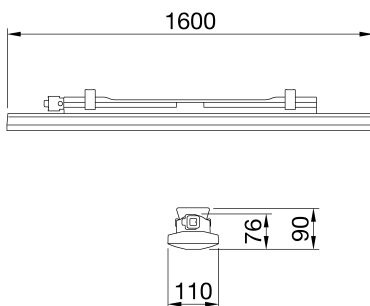

Smart [3] Plus is an IP66/69 ceiling light with LED Flip Type without wire boring, available in 3000K, 4000K, 5700K, with CRI ≥80 and ≥90. IK08 body in self-extinguishing polycarbonate RAL7035, for industrial applications and ideal for production areas, warehouses, and logistics areas. Can replace high flux and lowbay fluorescent devices up to 10,000lm. Available in sizes 1200, 1600mm, powers from 38W to 63W, flows from 4,000lm to 10,000lm, with integrated On/Off or DALI power and 3 different optical solutions, Transparent, Opal and Transparent screen with medium-beam optics complete with TIR lens made of PMMA. The version with through wiring has pre-wired mechanical and electrical components, with a maximum of 25 devices installed in a continuous row. It is possible to install the suspension and wall appliance, accessories bracket GW with inclination of 30° or 45° on the vertical axis. An integrated DALI emergency kit version is available.

| GENERAL INFORMATION | | OPTIC AND ILLUMINATING FEATURES | |
|---|---|-------------------------------------|--|
| Context | Lighting of warehouses, indoor parking and industrial production rooms | Optic | Microprismatic transparent |
| Luminaire Application | LED fixture for general lighting Internal | Unified Glare Rating | UGR ≤ 25 (4H/4H) |
| Unique digital code (Datamatrix) | Datamatrix | Lumen output (lm) | 5900 (500 Em.) |
| Colour | Grey RAL 7035 | Efficacy (lm/W) | 107 |
| Type of light source | LED | Colour temperature | 4000 K |
| System power | 50W (+5W Emerg.) | Colour Rendering Index | CRI>90 |
| LED Lifetime | L90B10(Tq25°C)=50.000h; L80B10(Tq25°C)=100.000h; L80B10(Tq50°C)=94.000h | Standard Deviation Colour Matching | SDCM = 3 |
| Weight (kg) | 4.2 | Photobiological Risk Class | RG0 |
| Warranty | 5 years | Standard | EN60598-1; IEC 62778; IEC62471; 60598-2-22 |
| Stocking temperature | -15°C ÷ +25°C | ELETRICAL AND LIGHTING FEATURES | |
| Operating temperature | +5°C ÷ +40 °C | Supply voltage | 220 - 240 V |
| MATERIALS | | Rated frequency (Hz) | 50 / 60 |
| Body | Polycarbonate | Driver | Included |
| Shield type | UV stabilised polycarbonate | Driver failure rate | F10 = 100.000h Tq25°C |
| Optic | Integrated in the screen | Overvoltage protection | DM 1KV / CM 2KV |
| Gasket | CNC deposited sealant | Control System | 1 x DALI DT6 + 1 x DALI DT1 (Emerg. 3h) |
| Locking Hook | - | INSTALLATION AND MAINTENANCE | |
| External screw | - | Mounting and installation | Ceiling - Wallmounting - Suspension |
| Colour | RAL7035 colored PC paste | Tilt | With fixing bracket |
| STANDARDS AND APPROVALS | | Wiring | With GW connect watertight connector |
| Classification | KITE MARK (Emergency KIT) | Fixing | Stainless steel support |
| Device with reduced surface temperature | Yes | Light source replaceability | Non-replaceable |
| DIN 18032-3 certification | Not available | Controlgear replaceability | Non-replaceable |
| IPEA | - | Driver Box | Built-in |
| Insulation class | II | Maximum surface exposed to the wind | - |
| IP degree | IP65 | - | - |
| Mechanical resistance | IK08 | - | - |
| Glow Wire Test | 850 °C | - | - |

DIMENSIONAL



PHOTOMETRIC DISTRIBUTION

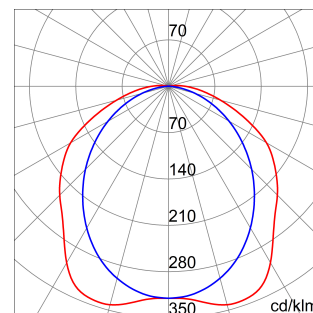

TECHNICAL SYMBOLOGY



IP
IP65

IK
IK08

GWT
850 °C



Product Data Sheet
GWS3325AT940

SMART [3] PLUS

STANDARDS/APPROVALS

