

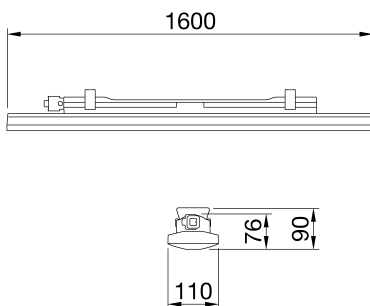

Smart [3] Plus is an IP66/69 ceiling light with LED Flip Type without wire boring, available in 3000K, 4000K, 5700K, with CRI ≥80 and ≥90. IK08 body in self-extinguishing polycarbonate RAL7035, for industrial applications and ideal for production areas, warehouses, and logistics areas. Can replace high flux and lowbay fluorescent devices up to 10,000lm. Available in sizes 1200, 1600mm, powers from 38W to 63W, flows from 4,000lm to 10,000lm, with integrated On/Off or DALI power and 3 different optical solutions, Transparent, Opal and Transparent screen with medium-beam optics complete with TIR lens made of PMMA. The version with through wiring has pre-wired mechanical and electrical components, with a maximum of 25 devices installed in a continuous row. It is possible to install the suspension and wall appliance, accessories bracket GW with inclination of 30° or 45° on the vertical axis. An integrated DALI emergency kit version is available.

GENERAL INFORMATION		OPTIC AND ILLUMINATING FEATURES	
Context	Lighting of warehouses, indoor parking and industrial production rooms	Optic	Wide opal
Luminaire Application	LED fixture for general lighting Internal	Unified Glare Rating	UGR ≤ 25 (4H/4H)
Unique digital code (Datamatrix)	Datamatrix	Lumen output (lm)	5600 (460 Em.)
Colour	Grey RAL 7035	Efficacy (lm/W)	95
Type of light source	LED	Colour temperature	4000 K
System power	50W (+5W Emerg.)	Colour Rendering Index	CRI>90
LED Lifetime	L90B10(Tq25°C)=50.000h; L80B10(Tq25°C)=100.000h; L80B10(Tq50°C)=94.000h	Standard Deviation Colour Matching	SDCM = 3
Weight (kg)	4.2	Photobiological Risk Class	RG0
Warranty	5 years	Standard	EN60598-1; IEC 62778; IEC62471; 60598-2-22
Stocking temperature	-15°C ÷ +25°C	ELETRICAL AND LIGHTING FEATURES	
Operating temperature	+5°C ÷ +40 °C	Supply voltage	220 - 240 V
MATERIALS		Rated frequency (Hz)	50 / 60
Body	Polycarbonate	Driver	Included
Shield type	UV stabilised polycarbonate	Driver failure rate	F10 = 100.000h Tq25°C
Optic	Integrated in the screen	Overvoltage protection	DM 1KV / CM 2KV
Gasket	CNC deposited sealant	Control System	1 x DALI DT6 + 1 x DALI DT1 (Emerg. 3h)
Locking Hook	-	INSTALLATION AND MAINTENANCE	
External screw	-	Mounting and installation	Ceiling - Wallmounting - Suspension
Colour	RAL7035 colored PC paste	Tilt	With fixing bracket
STANDARDS AND APPROVALS		Wiring	With GW connect watertight connector
Classification	KITE MARK (Emergency KIT)	Fixing	Stainless steel support
Device with reduced surface temperature	Yes	Light source replaceability	Non-replaceable
DIN 18032-3 certification	Not available	Controlgear replaceability	Non-replaceable
IPEA	-	Driver Box	Built-in
Insulation class	II	Maximum surface exposed to the wind	-
IP degree	IP65		-
Mechanical resistance	IK08		-
Glow Wire Test	850 °C		-

### DIMENSIONAL



### PHOTOMETRIC DISTRIBUTION

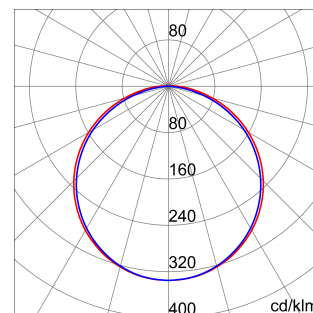

### TECHNICAL SYMBOLOGY



**IP**  
IP65

**IK**  
IK08

**GWT**  
850 °C



Product Data Sheet  
**GWS3325AP940**

SMART [3] PLUS

STANDARDS/APPROVALS

