



Smart [3] Plus is an IP66/69 ceiling light with LED Flip Type without wire boring, available in 3000K, 4000K, 5700K, with CRI ≥80 and ≥90. IK08 body in self-extinguishing polycarbonate RAL7035, for industrial applications and ideal for production areas, warehouses, and logistics areas. Can replace high flux and lowbay fluorescent devices up to 10,000lm. Available in sizes 800, 1200, 1600mm, powers from 25W to 63W, flows from 4,000lm to 10,000lm, with integrated On/Off or DALI power and 3 different optical solutions, Transparent, Opal and Transparent screen with medium-beam optics complete with TIR lens made of PMMA. The version with through wiring has pre-wired mechanical and electrical components, with a maximum of 25 devices installed in a continuous row. It is possible to install the suspension and wall appliance, accessories bracket GW with inclination of 30° or 45° on the vertical axis. An emergency kit version is available.

GENERAL INFORMATION

Context	Lighting of warehouses, indoor parking and industrial production rooms
Luminaire	LED fixture for general lighting
Application	Internal
Unique digital code (Datamatrix)	Datamatrix
Colour	Grey RAL 7035
Type of light source	LED
System power	61 W
LED Lifetime	L90B10(Tq25°C)=50.000h; L80B10(Tq25°C)=100.000h; L80B10(Tq50°C)=94.000h
Weight (kg)	3.8
Warranty	5 years
Stocking temperature	-25 +80 °C
Operating temperature	-25 +50 °C

MATERIALS

Body	Polycarbonate
Shield type	UV stabilised polycarbonate
Optic	Integrated in the screen
Gasket	CNC deposited sealant
Locking Hook	-
External screw	-
Colour	RAL7035 colored PC paste

STANDARDS AND APPROVALS

Classification	-
Device with reduced surface temperature	Yes
DIN 18032-3 certification	Not available
IPEA	-
Insulation class	II
IP degree	IP66/IP69
Mechanical resistance	IK08
Glow Wire Test	850 °C

OPTIC AND ILLUMINATING FEATURES

Optic	Wide opal
Unified Glare Rating	UGR ≤ 25 (4H/4H)
Lumen output (lm)	9000
Efficacy (lm/W)	148
Colour temperature	5700 K
Colour Rendering Index	CRI>80
Standard Deviation Colour Matching	SDCM = 3
Photobiological Risk Class	RG0
Standard	EN60598-1; IEC 62778; IEC62471

ELECTRICAL AND LIGHTING FEATURES

Supply voltage	220-240 V
Rated frequency (Hz)	50/60 Hz
Driver	Included
Driver failure rate	F10 = 100.000h Tq25°C
Overvoltage protection	DM 1KV / CM 2KV
Control System	Through wiring - On/Off

INSTALLATION AND MAINTENANCE

Mounting and installation	Ceiling - Wallmounting - Suspension
Tilt	With fixing bracket
Wiring	With GW connect watertight connector
Fixing	Stainless steel support
Light source replaceability	Non-replaceable
Controlgear replaceability	Non-replaceable
Driver Box	Built-in
Maximum surface exposed to the wind	-

DIMENSIONAL

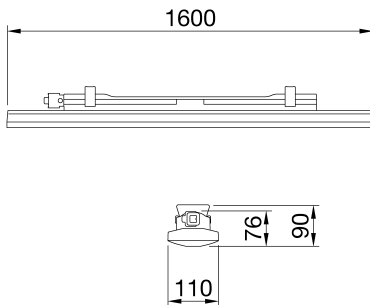

PHOTOMETRIC DISTRIBUTION

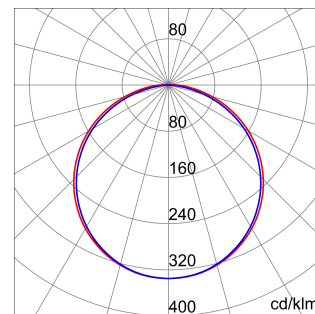

TECHNICAL SYMBOLOGY



IP

IP66/IP69

IK

IK08

GWT

850 °C



Product Data Sheet
GWS3322BP857

SMART [3] PLUS

STANDARDS/APPROVALS

