



Systems of accessories for electrical installations used for residential, tertiary and industrial applications. The system consists of fasteners for pipes and cables, cable fittings, accessories for rigid pipes (RK Series) and flexible conduit (DF Series). The system include also a wide variety of cable ties (52FS Range) and terminal blocks (44 Range).

Colour	Grey RAL 7035	IP degree	IP68
Material	Nylon	For cables Ø (mm)	from 30 to 38
ISO pitch	50x1.5	Mounting hole Ø (mm)	50
Description	Cable gland	Type of pitch	M50
Glow Wire Test	650 °C	Operating temperature	-25 +65 °C
Electrocod	36B	Standard	EN 50262 - IEC 62444 - IEC/EN 60243

BEHAVIOUR WITH CHEMICAL AND ATMOSPHERIC AGENTS

Saline solution	Acids		Bases		Solvents				Mineral oil	UV rays
	Concentrated	Diluted	Concentrated	Diluted	Hexane	Benzol	Acetone	Ethyl alcohol		
Resistant	Limited resistance	Limited resistance	Resistant	Resistant	Resistant	Resistant	Resistant	Resistant	Resistant	Limited resistance

DIMENSIONAL

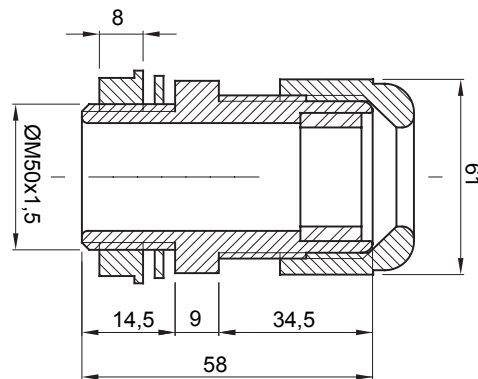

TECHNICAL SYMBOLOGY

IP

IP68

GWT

650 °C



-25 +65 °C

STANDARDS/APPROVALS

