

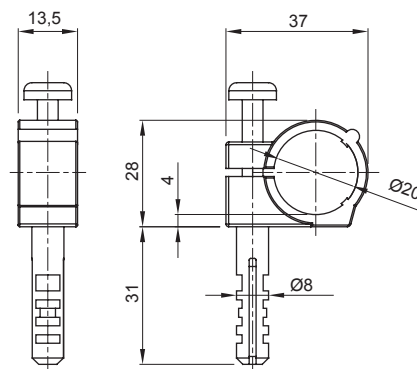

Systems of accessories for electrical installations used for residential, tertiary and industrial applications. The system consists of fasteners for pipes and cables, cable fittings, accessories for rigid pipes (RK Series) and flexible conduit (DF Series). The system include also a wide variety of cable ties (52FS Range) and terminal blocks (44 Range).

Colour	Grey RAL 7035	Fixing	Post bracket
Glow Wire Test	750 °C	Ø wall plug (mm)	8
For external conduits (mm)	20	Type	With wall plug
Operating temperature	-5 +60 °C	Electrocod	21221
Standard	EN 61386-1 (when applicable)		

DIMENSIONAL



TECHNICAL SYMBOLOGY

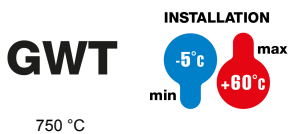

STANDARDS/APPROVALS

