

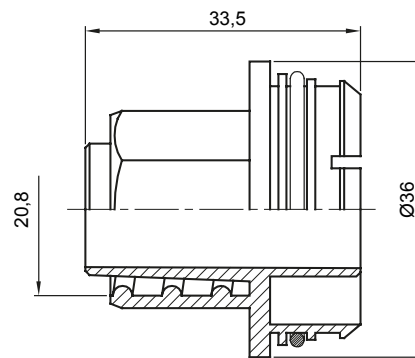

Routing components for rigid protective conduits with IP40 and IP67 protection degree.

Colour	Grey RAL 7035	Characteristics	Halogen free
Sheath Ø (mm)	16	Electrocod	21221

DIMENSIONAL

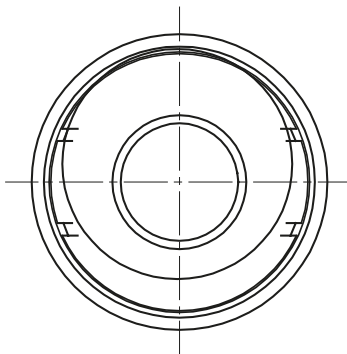

TECHNICAL SYMBOLOGY



STANDARDS/APPROVALS

