

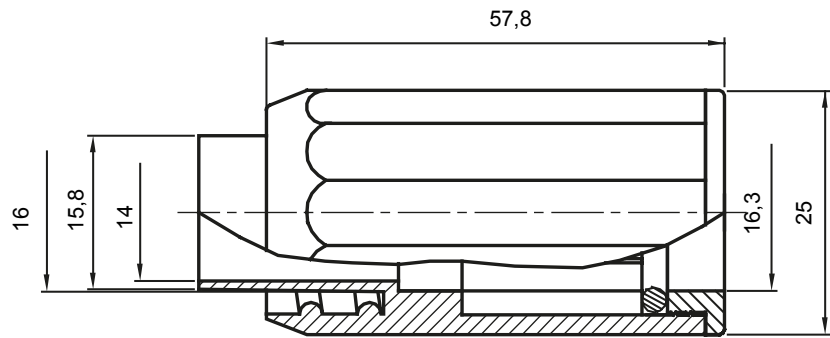

Routing components for rigid protective conduits with IP40 and IP67 protection degree.

| | | | |
|------------------|--|---------------|-------|
| Colour | Grey RAL 7035 | IP degree | IP65 |
| Conduits Ø (mm) | 16 | Sheath Ø (mm) | 16 |
| Type of material | Halogen-free in compliance with EN 60754-2 | Electrocod | 21221 |

DIMENSIONAL

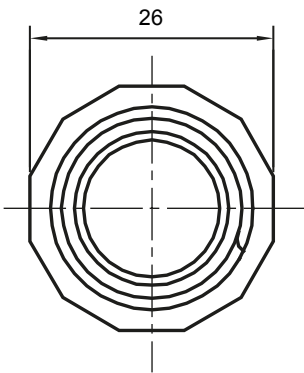

TECHNICAL SYMBOLOGY

IP

HF
HALOGEN FREE

IP65

STANDARDS/APPROVALS

