

For boards LxH (mm)	236x316	For boards	44 CEP
Type of material	Insulation	Electrocod	1320

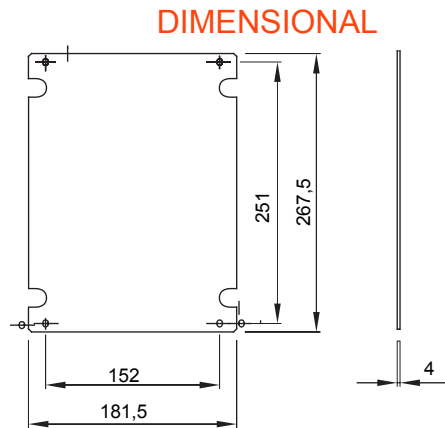

### STANDARDS/APPROVALS

