

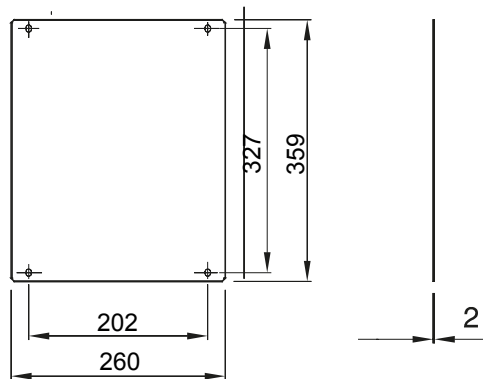

Accessories and complementary items for distribution and automation boards range 46.

For boards LxH (mm)	310x425	Suitable for	46QP - 46QM - 46QX
Type	Full	Type of material	Steel
Electrocod	0303		

DIMENSIONAL



STANDARDS/APPROVALS

