



70 RT HP is a new range of 16A to 160A switch disconnecters in isolating material and metal, supplied in a box. Available in control and emergency versions, the range is completed by board versions for front-panel or DIN rail assembly, in 16 to 63A options, all of which can be equipped with auxiliary contacts. These devices have been designed to deliver the ultimate in reliability, functionality and performance. They offer a technologically advanced solution that simplifies installation, reduces wiring times and ensures maximum safety and robustness, even in the most demanding conditions, thanks to the use of high-performance materials.

Version	Box	Material	Insulation
Type	Command	Rated current (A)	100
No. of poles	4P	Circuit breaker	Rotary isolator
IP degree	IP66/IP67/IP69	Mechanical resistance	IK08
Ambient temperature	-25 +60 °C	Lid screws (no. and type)	4 insulation
Lockable	YES (max. 3 locks in ON and OFF)	Type of accessory	Max. 4 auxiliary contacts
Current in AC22 (415V)	100	Current in AC23 (415V)	100
Cable section	Max 70 mm ²	Outer dim. LxHxD (mm)	236,5x316x178
Electrocod	1742		

BEHAVIOUR WITH CHEMICAL AND ATMOSPHERIC AGENTS

Saline solution	Acids		Bases		Solvents				Mineral oil	UV rays
	Concentrated	Diluted	Concentrated	Diluted	Hexane	Benzol	Acetone	Ethyl alcohol		
Resistant	Limited resistance	Resistant	Not resistant	Limited resistance	Limited resistance	Not resistant	Not resistant	Limited resistance	Resistant	Resistant

DIMENSIONAL

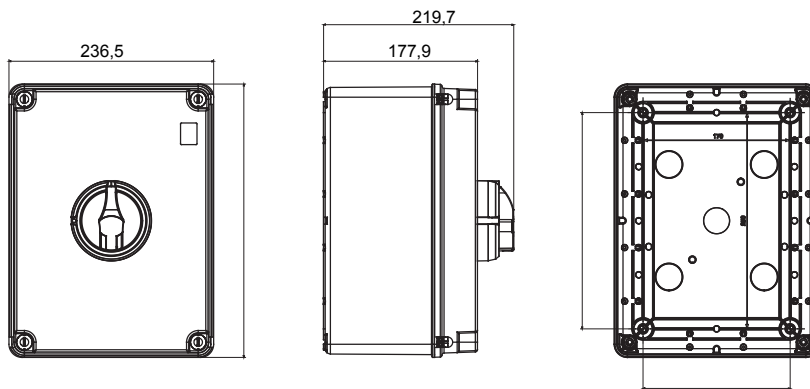

TECHNICAL SYMBOLOGY

IP **IK**

IP66/IP67/IP69

IK08

STANDARDS/APPROVALS

