

Flange dimensions (mm)	85x75	Type	Flush-mounting socket-outlet with shutter
Thermo-pressure with ball	125 °C (active parts) - 80 °C (passive parts)	IP degree	IP54
No. of poles	2P+E	Frequency	50/60 Hz
Terminal tightening capacity	1-2.5 mm ² flexible cables - 1.5-2.5 mm ² rigid cables	Operating temperature	-25 +55 °C
Type of wiring	With screw	Electrocod	2211
Glow wire test	850 °C (active parts) - 650 °C (passive parts)	Colour	Blue
Rated current (A)	16	Rated voltage	200-250 V
Standard	German		

BEHAVIOUR WITH CHEMICAL AND ATMOSPHERIC AGENTS

Saline solution	Acids		Bases		Solvents				Mineral oil	UV rays
	Concentrated	Diluted	Concentrated	Diluted	Hexane	Benzol	Acetone	Alcohol		
Resistant	Not resistant	Limited resistance	Not resistant	Limited resistance	Limited resistance	Not resistant	Not resistant	Limited resistance	Limited resistance	Limited resistance

DIMENSIONAL

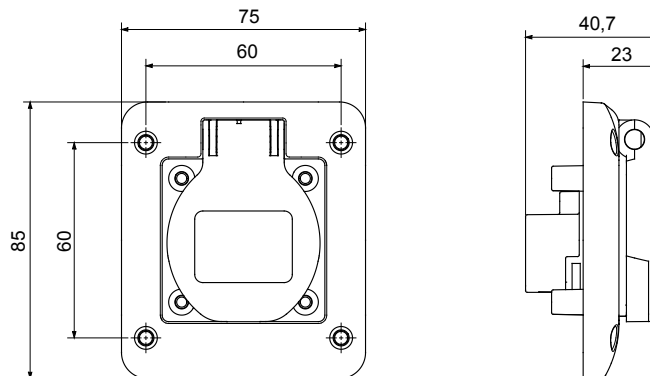

TECHNICAL SYMBOLOGY

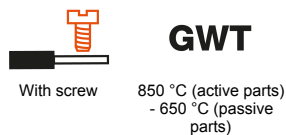

STANDARDS/APPROVALS

