



A range of trailing and fixed plugs and socket-outlets for industrial use, complying with the dimensional and performance standards unified at International level (IEC 60309) and assimilated by the European Standards (EN 60309) and Italian Standards (CEI 23-12). Socket-outlets and plugs with a rated current of 63 and 125A are equipped with an extra pilot contact (CP) for creating an electric interlock. The range is completed with 90° fixed plugs and 10° and 90° fixed socket-outlets. Sleeves and pins are obtained from solid brass bar, type Pt. CuZn40Pb2 (Cu 58%, Zn 40%, Pb 2%); anti-loosening terminals with unlosable screws, and built-in cable clamp with anti-abrasion cable gland.

| | | | |
|----------------------------|------------|------------------------------|--|
| Colour | Red | Rated current (A) | 63 |
| IP degree | IP67 | No. of poles | 2P+E |
| Mechanical resistance | IK08 | Reference h | 9 |
| Rated voltage | 380-415 V | Type | 90° angled surface mounting inlet |
| Frequency | 50/60 Hz | Terminal tightening capacity | 6-16mm ² flexible cables - 6-25mm ² rigid cables |
| Operating temperature | -25 +55 °C | Type of wiring | Mantle terminal |
| Electrocod | 2231 | Glow wire test | 850 °C (active parts) - 650 °C (passive parts) |
| Total number of operations | > 2000 | Breaking capacity at 1.1 Un | 79 A |
| Insulation resistance | > 10 MΩ | Thermo-pressure with ball | 125 °C (active parts) - 80 °C (passive parts) |

BEHAVIOUR WITH CHEMICAL AND ATMOSPHERIC AGENTS

| Saline solution | Acids | | Bases | | Solvents | | | | Mineral oil | UV rays |
|-----------------|---------------|--------------------|--------------------|-----------|-----------|-----------|-----------|------------|-------------|-----------|
| | Concentrated | Diluted | Concentrated | Diluted | Hexane | Benzol | Acetone | Alcohol | | |
| Resistant | Not resistant | Limited resistance | Limited resistance | Resistant | Resistant | Resistant | Resistant | Resistente | Resistant | Resistant |

DIMENSIONAL

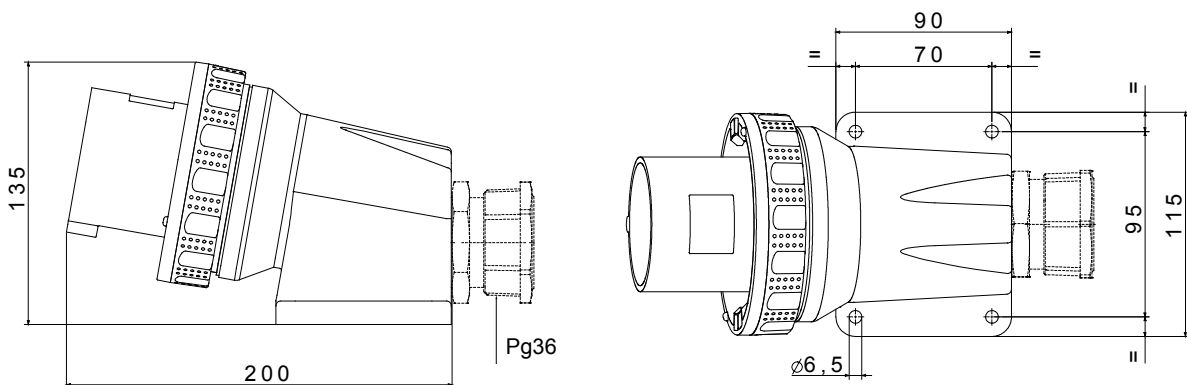

TECHNICAL SYMBOLOGY

IP

IP67

IK

IK08



-25 +55 °C



Mantle terminal

GWT

850 °C (active parts)
- 650 °C (passive parts)



125 °C (active parts)
- 80 °C (passive parts)

STANDARDS/APPROVALS

