



Description Interruttore automatico scatolato
 Code MSXE 160
 No. of poles 3P+N
 Rated current 40 A
 Release Electronic

ELECTRICAL CHARACTERISTICS

Standard	IEC/EN 60947-2
Use category	A
Rated frequency (Hz)	50 / 60
Rated operating voltage (Ue)	690 Vac
Rated impulse withstand voltage (Uimp)	8 kV
Overvoltage category	IV
Insulation voltage (Ui)	800 V
Thermal regulation	0,4 - 0,5 - 0,63 - 0,8 - 0,9 - 0,95 - 1 x In
Magnetic regulation	Electronic LSI
Neutral protection	Not protected
Total power loss	2.24 W
Rated short-circuit current making capacity (Icm)	-
Rated short-time withstand current for 0,3s (Icw)	-
I _{dn} regulation	-
DT regulation	-

SERVICE BREAKING CAPACITY (ICU)

220/240Vac	85 kA
400/415Vac	65 kA
440Vac	50 kA
525Vac	25 kA
690Vac	7,5 kA
250Vdc	-

MECHANICAL CHARACTERISTICS

Execution	Fixed - Plug-in
DIN rail mounting	No
Can be equipped with motor operator	Yes
Compatible interlock	Lever - Cable
Terminals supplied	Front FC
Assembly position	Any
Upline/downline power supply	Yes
Electrical life (415Vac)	10.000 cycles
Mechanical life	30.000 cycles
Operating temperature	-5°C +65°C
Stocking temperature	-20° +65°
Weight (kg)	3.1
Width	140 mm
Height	165 mm
Depth	103 mm

RATED BREAKING CAPACITY (ICS)

220/240Vac	85 kA	220/240Vac	85 kA
400/415Vac	65 kA	400/415Vac	36 kA
440Vac	50 kA	440Vac	25 kA
525Vac	25 kA	525Vac	25 kA
690Vac	7,5 kA	690Vac	7,5 kA
250Vdc	-	250Vdc	-

DIMENSIONAL

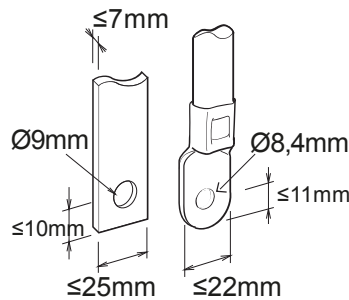



Product Data Sheet

GWD9342

MSX

STANDARDS/APPROVALS

