

A complete, versatile system of modular containers, perfectly integrable in the SYSTEM domestic range and able to meet the high protection installation requirements of the residential, commercial and industrial sectors. The 27 COMBI range is available both in the IP40 version and in watertight versions with IP55, IP65 and IP66 degree of protection, recommended for all outdoor applications which are subjected to extreme atmospheric conditions.

Description	4 modules	No. gangs	4
Colour	White RAL 9010	No. knockout holes Ø23	1 on the bottom
Type of knockout holes	Removable with tool	IP degree	IP40
Insulation class	II	Mechanical resistance	IK07
Compartment pre-arrangement	1	Characteristics	Halogen free
Lid screws	Corrosion-resistant steel	Torque screws tightening	0.8 Newton/meter
Outer dim. LxHxD (mm)	132x82x54	Glow Wire Test	650 °C
Thermo-pressure with ball	70 °C	Standard	EN 50085-2-1
Installation temperature	-5 +60 °C	Electrocod	0212

BEHAVIOUR WITH CHEMICAL AND ATMOSPHERIC AGENTS

Saline solution	Acids		Bases		Solvents				Mineral oil	UV rays
	Concentrated	Diluted	Concentrated	Diluted	Hexane	Benzol	Acetone	Alcohol		
Resistant	Limited resistance	Resistant	Resistant	Resistant	Limited resistance	Not resistant	Not resistant	Not resistant	Limited resistance	Resistant

DIMENSIONAL

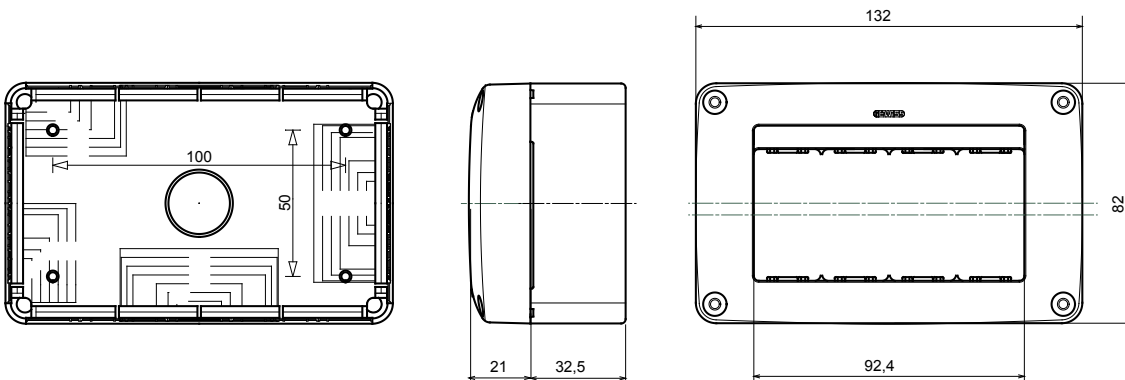

TECHNICAL SYMBOLOGY



IP
IP40



II

IK
IK07



Halogen free

GWT
650 °C

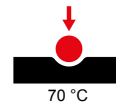

70 °C

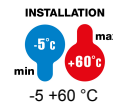

INSTALLATION
-5 +60 °C

STANDARDS/APPROVALS

